

10.15 - 10.45 WP1. Theory, instrument overview and status
10.45 – 11.15 WP1. IMS Electronics & IMS Mechanical design

11.15 – 11.45 Coffee break

11.45 – 12.15 WP2. Implementation of CAD, ECD, HECD, UV, IR, PD, and EID MS/MS techniques in Omnitrap

12.15-12.45 WP3. Development and application of H-atom bombardment techniques

12.45-13.45 Lunch

13.45-14.15 WP4. Development and application of Coulomb explosion MS/MS technique

TopSpec

WP1 – Omnitrap & IMS development and testing

D1.1 – 2xOMNI & 1x IMS installed

- T1.1 – mech design & pulsed EI source
- T1.2 – ion isolation simulation
- T1.3 – rect RF Generator
- T1.4 – assembly of omni's & ims
- T1.5 – ctrl software
- T1.6 – electronics testing and QE synch
- T1.7 – installation

D1.2 – Modifications

- T1.8 – software modification & requests

D1.2 – Serviced Omni's

- T1.8 – maintenance

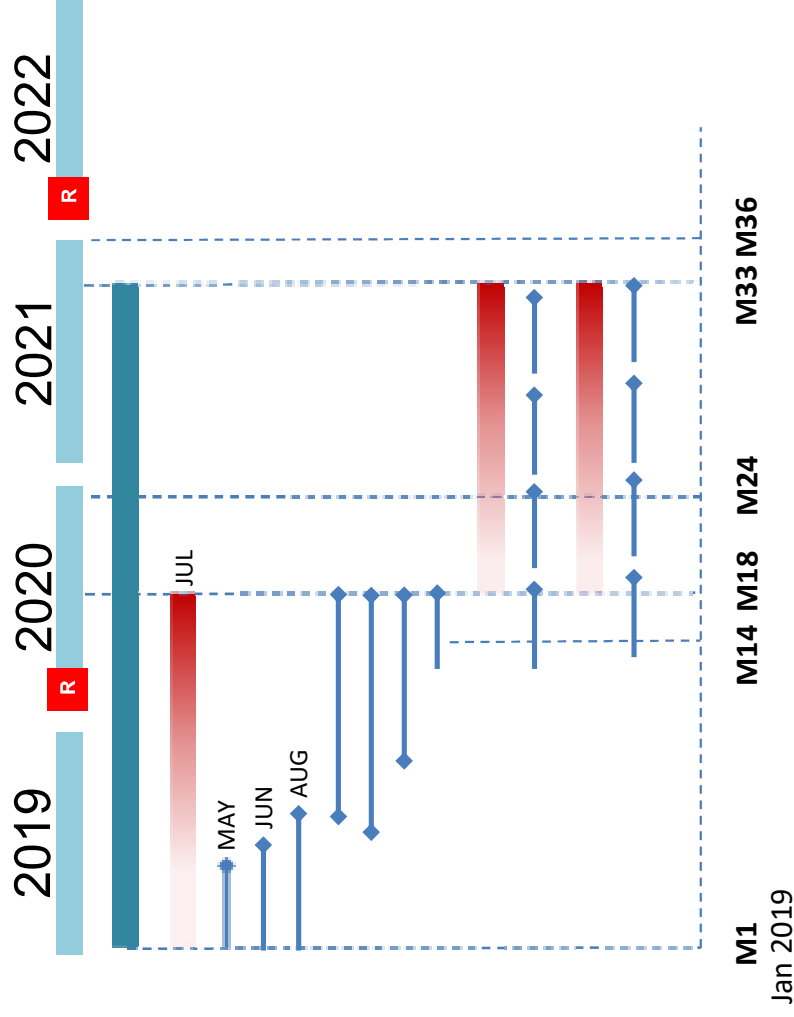

The Omnitrap activation platform

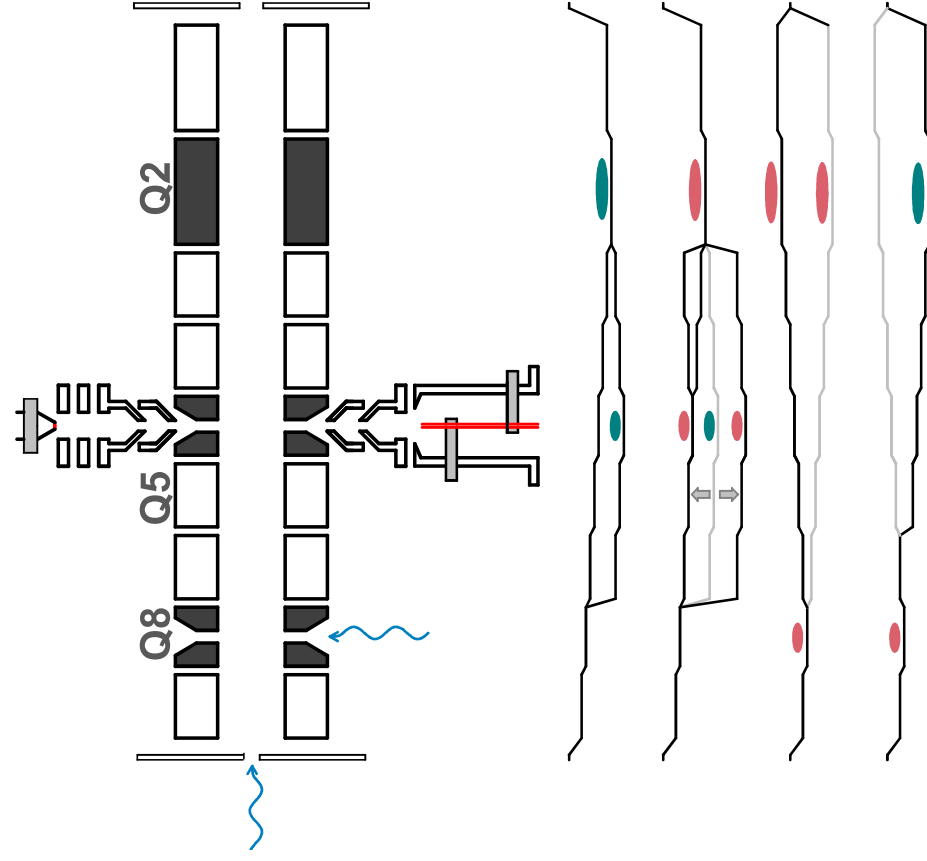

functionality

- **Trapping regions for processing ions:**
 - ▶ **Q2:** Resolving DC & duty cycle isolation dipolar excitation for CID, AC wave multi-notch isolation
 - ▶ **Q5:** external injection of electrons, ions and activated neutrals dipolar excitation for CID
 - ▶ **Q8:** optical access for photoionization & accumulation
- **Rectangular RF employed for radial trapping:**
 - ▶ extended m/z range trapping
 - ▶ frequency jumps - fast q_z parking
 - ▶ external injection of charged particles
- **Multi-level switched DCs applied to segments:**
 - ▶ lossless axial ion transfer
 - ▶ multiple trapping regions for sequential or parallel processing
 - ▶ KE resolved external injection of electrons, neutrals & ions
- **Dynamic control of pressure:**
 - ▶ CID at elevated pressure – dipolar excitation sin wave
 - ▶ collision free ion isolation, ECD, EID
 - ▶ fast thermalization

Omnitrap Ion Activation Network

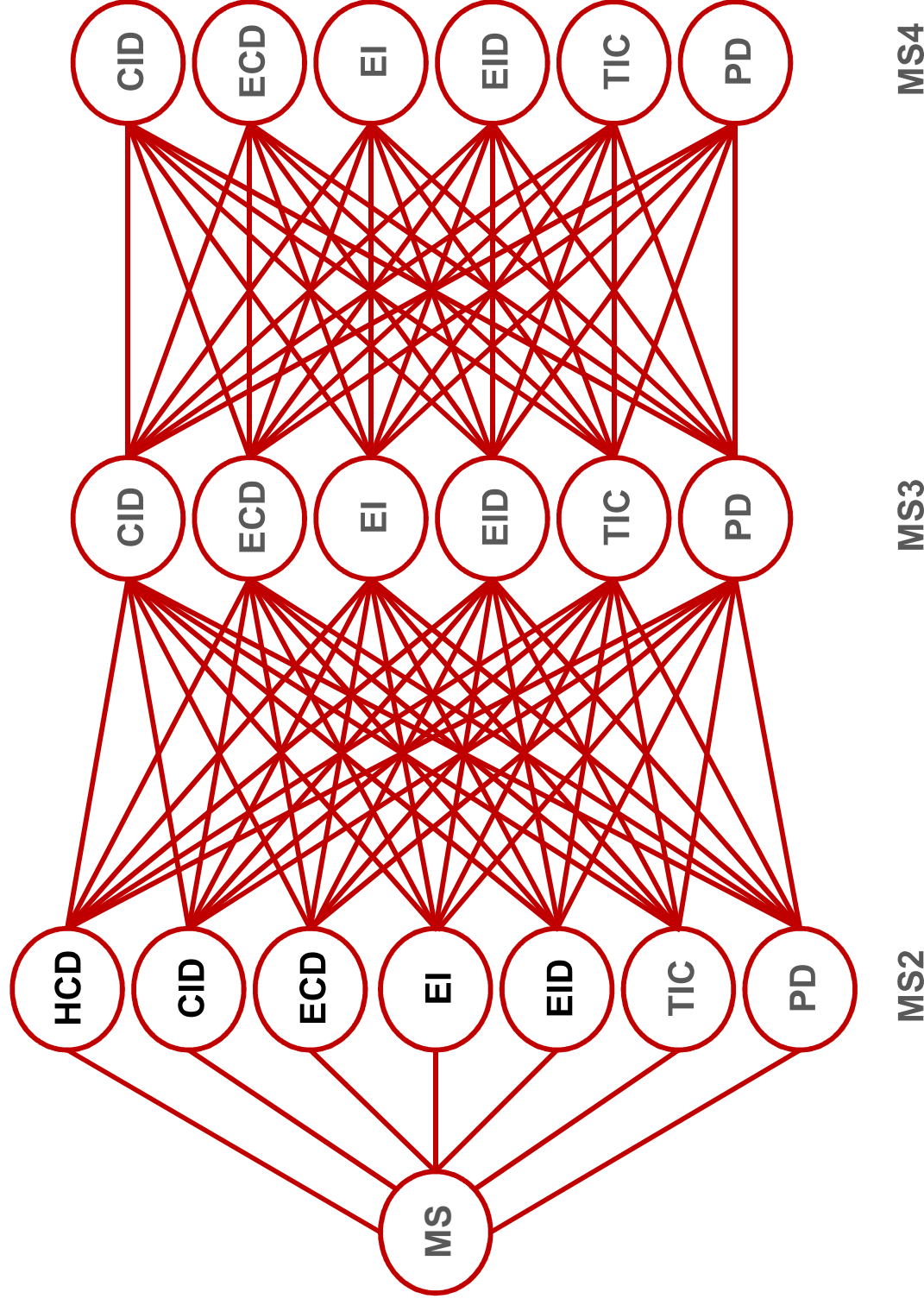

Extensions

HCD in omni ✓

CA ExD ✓

Hyperthermal H

SID

...

External RC Distribution Network

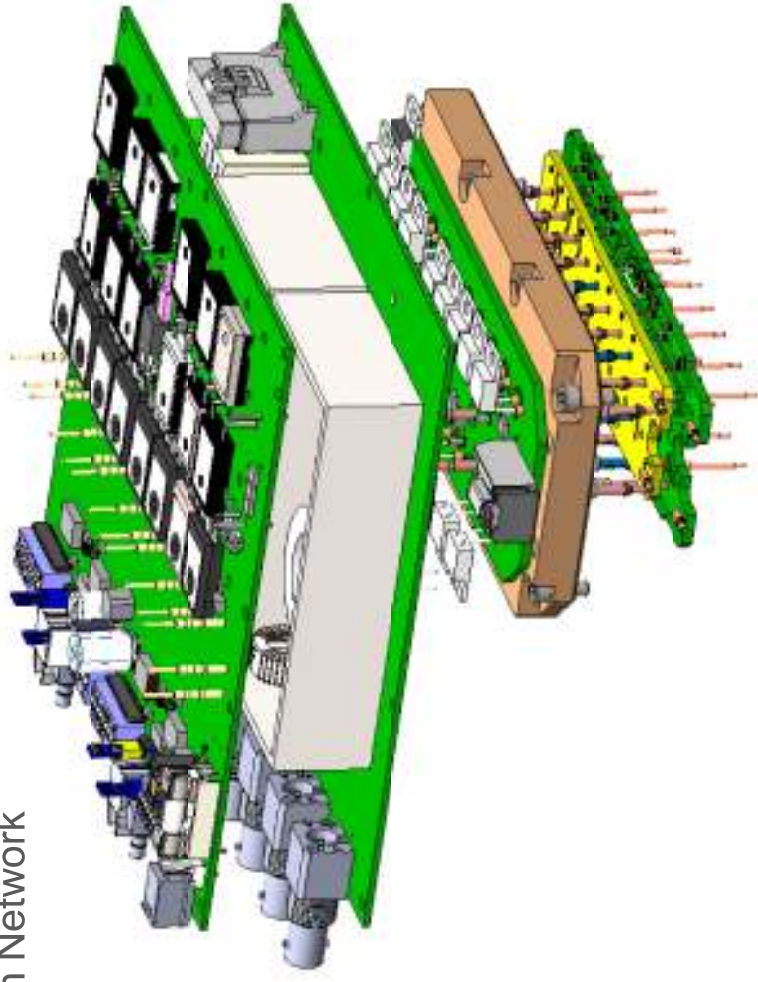
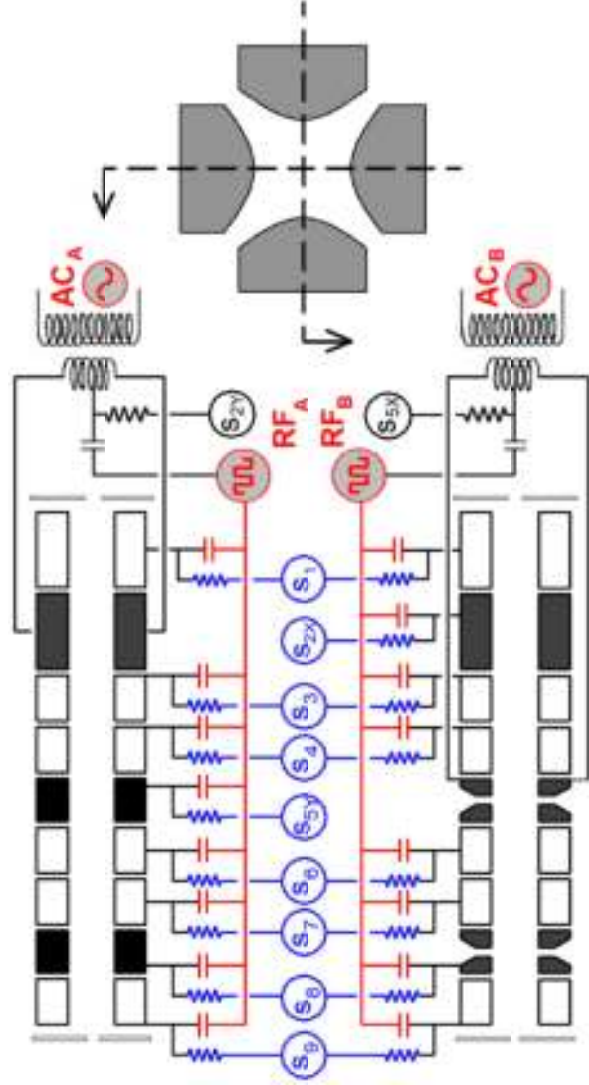

26 individual signals
applied to trap electrodes

WP1 – Omnitrap & IMS development and testing

T1.1 – mech design & pulsed EI source



TOPSPEC
upgraded design

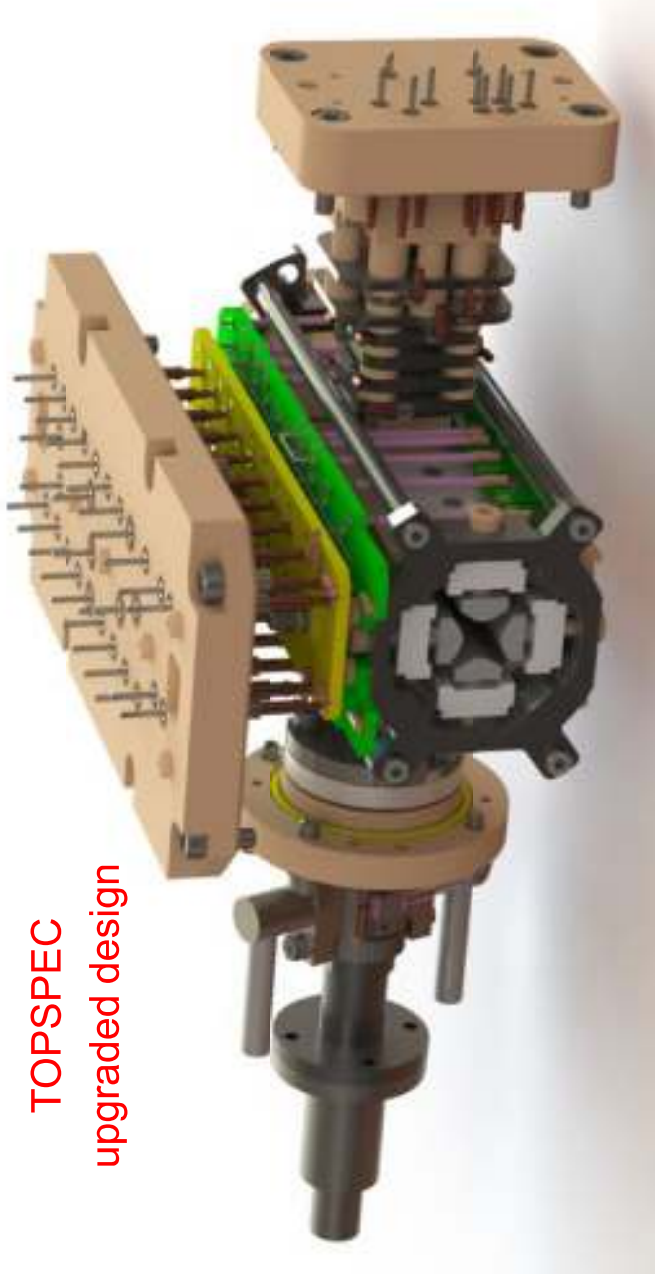

Omnitrap v2

250V_{op} Rectangular RF Generator ✓
Ext RC Distribution Network ✓
RF Amplitude Ctrl ✓

Sweep Isolation Resolution (83ms - 12.5MHz) ✓
RF Duty Cycle Isolation (35% @ 1MHz) ✓

Phase-Coherent Frequency Transitions ✓

Dipolar Excitation in Q5 (ECD-CID) ✓

Pulsed Electron Source (v2) ✓

Thermal (v3) & Hyperthermal H atom guns (v1)

Ion mobility drift cell / MSn-IMSn (v2)

WP1 – Omnitrap & IMS development and testing

T1.1 – mech design & pulsed EI source



QExactive HF mass spectrometer used for developing and debugging the omnitrap platform in Athens

Items evaluated experimentally and redesigned for further testing :

- Electron source (v2)
- Thermal H• source (v3)
- Hyperthermal H• source (v1)
- Ion Mobility Drift Cell (v2)
- 400V_{op} rect RF generator (v2)
- FPGA (v2)

WP1 – Omnitrap & IMS development and testing

T1.1 – mech design & pulsed EI source

Omnitrap QExactive™ HF

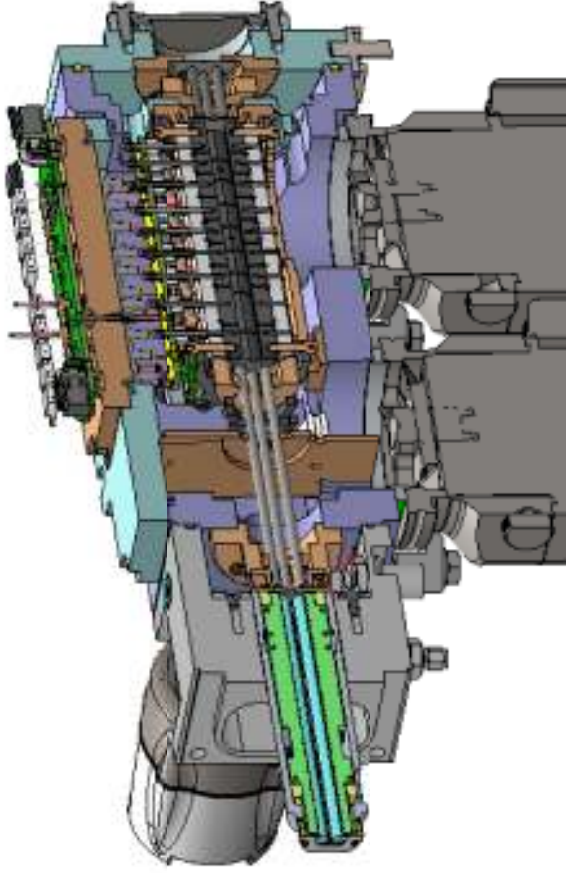

Omnitrap Exploris™ 480

- ◆ *Target both existing and new instrument platforms*
- ◆ *Exploris 480 offers Higher Resolution*

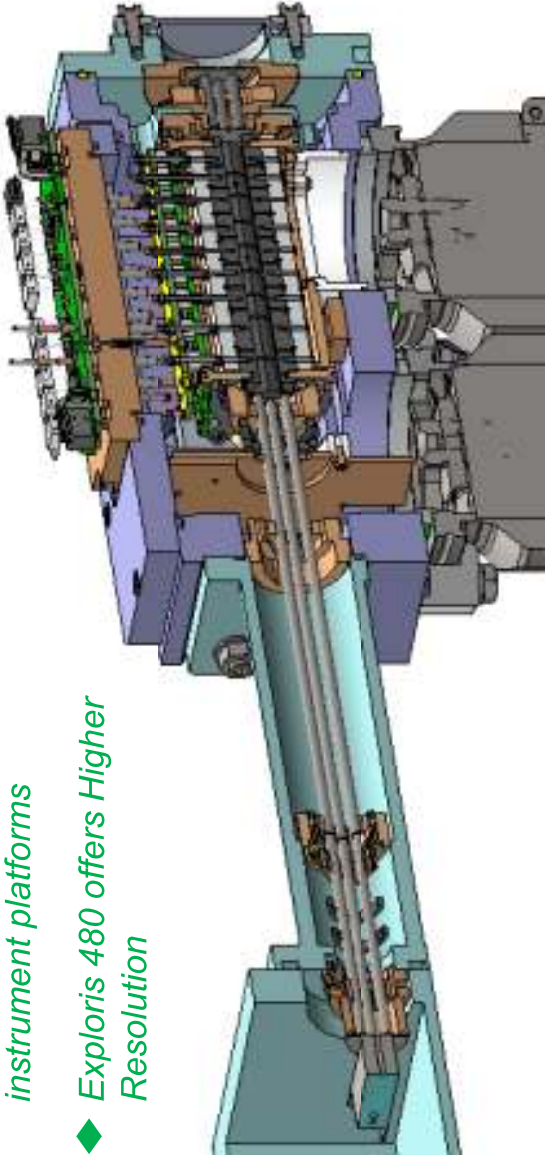

New features: Upgraded vacuum chamber design for enhanced pumping speed in RF hex bridge

New H₂ screen for minimizing gas load to orbitrap mass analyzer

New multipin feedthru for driving segmented extended-length RF hex bridge (Exploris config)

WP1 – Omnitrap & IMS development and testing

T1.1 – mech design & pulsed EI source

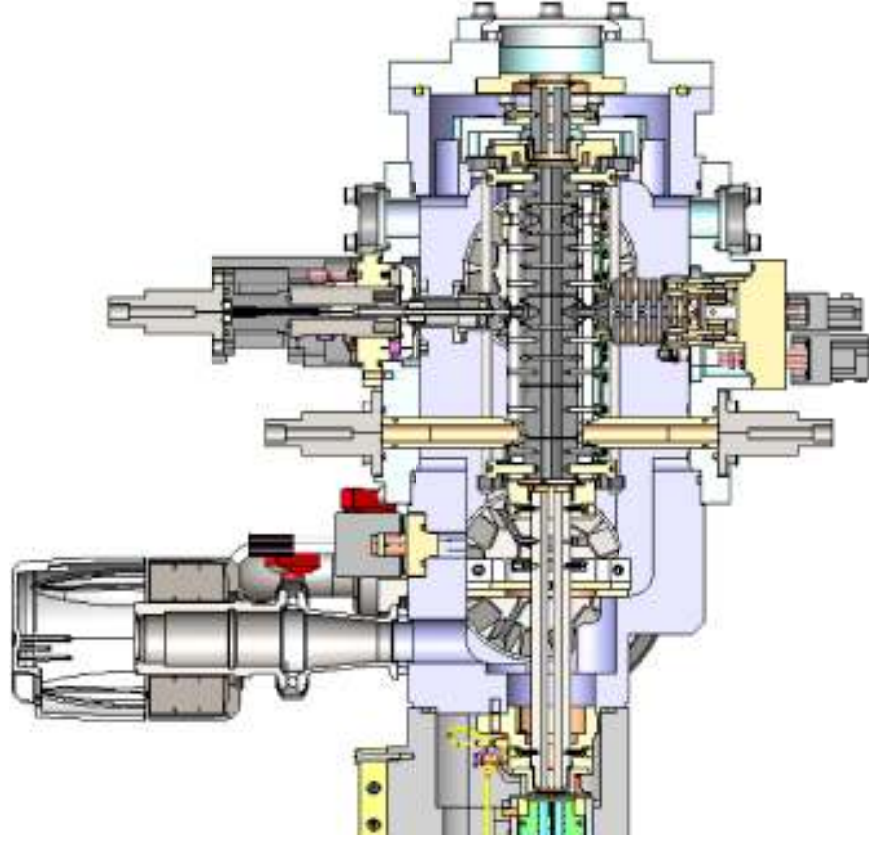

Omnitrap QExactive™ HF

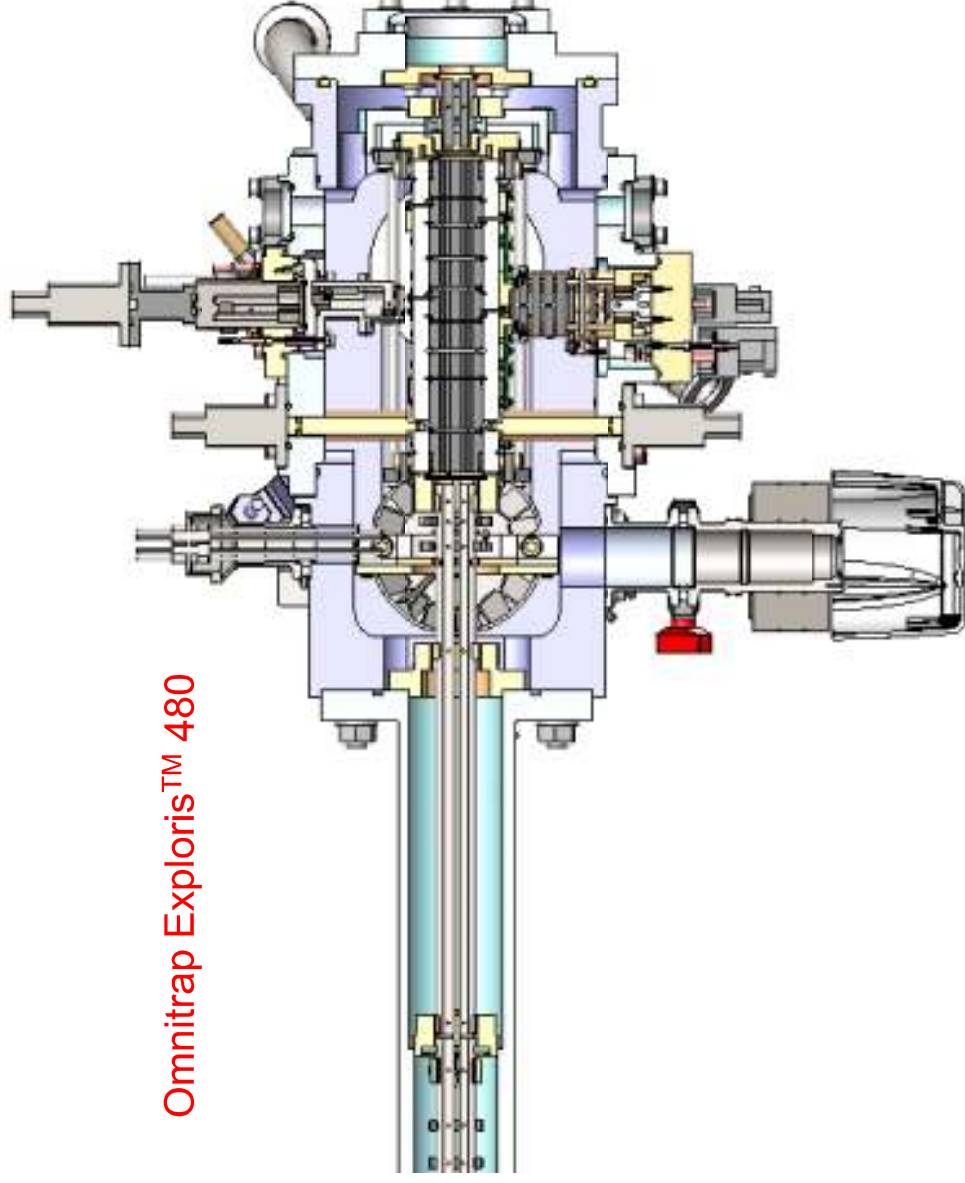

Omnitrap Exploris™ 480

WP1 – Omnitrapp & IMS development and testing

T1.1 – mech design & pulsed EI source

FPGA Board 1/3



FPGA Board 2/3



FPGA Board 3/3



Electron Source Ctrl Unit

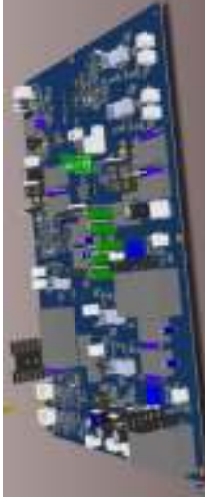

Multilevel DC Switch Unit & Rails Board



Uart Hub Communication Board



Electrometer



Rectangular RF Unit

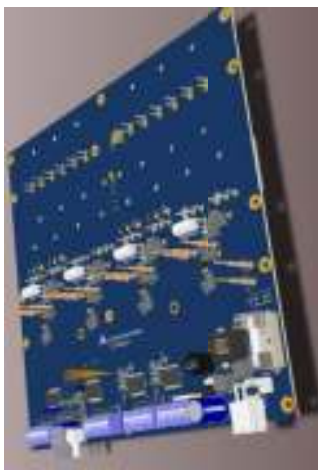
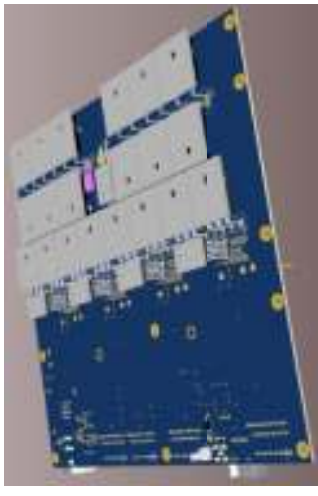

Power Board



Pulse Valve



Rectangular RF Cards



WP1 – Omnitrap & IMS development and testing

T1.1 – mech design & pulsed EI source

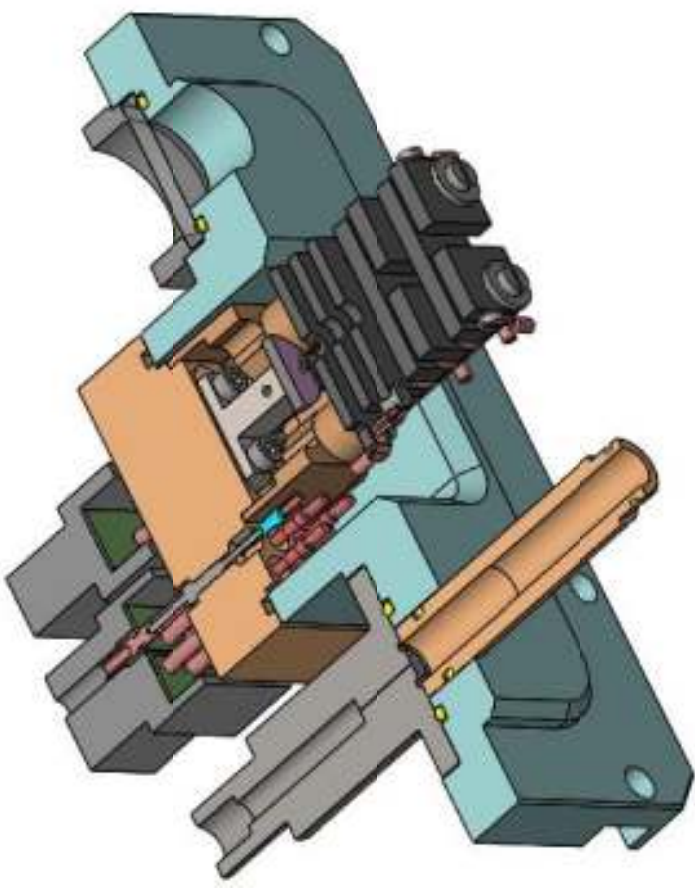
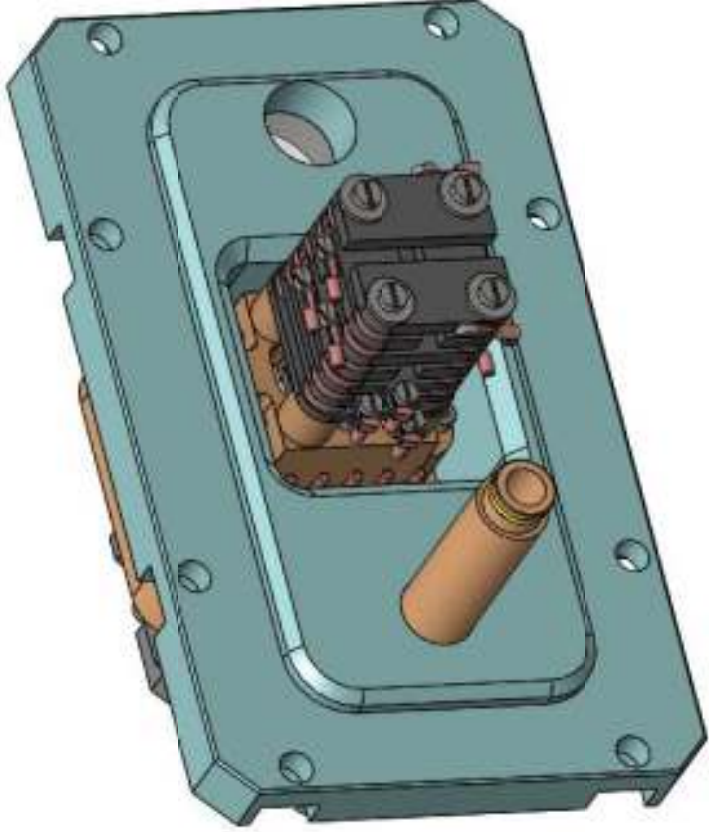

new electron source design with two-stage deflectors in both vertical and horizontal directions
new electronics for pulsed operation at high voltage

WP1 – Omnitrapp & IMS development and testing

T1.1 – mech design & pulsed EI source

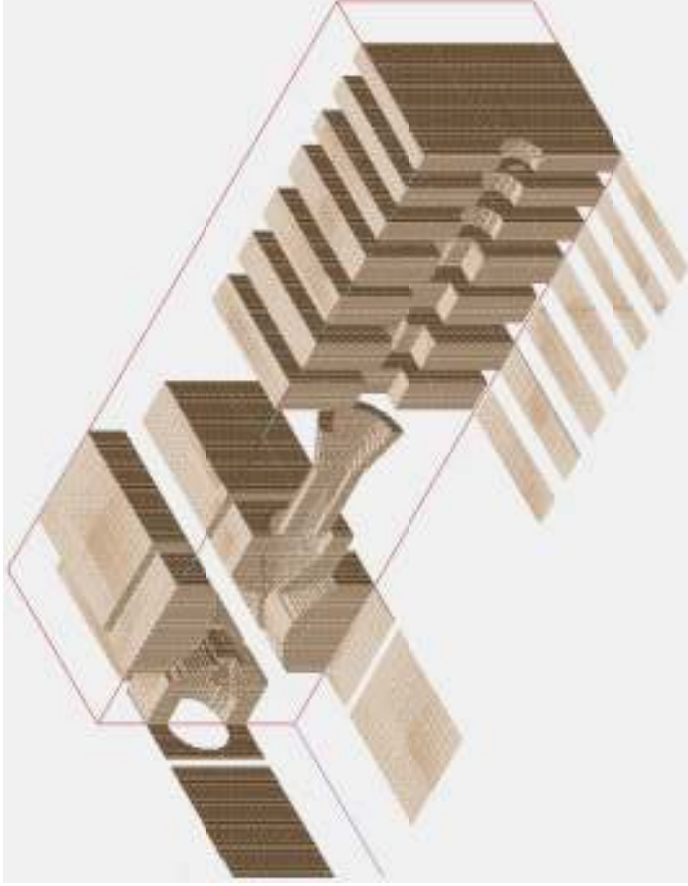
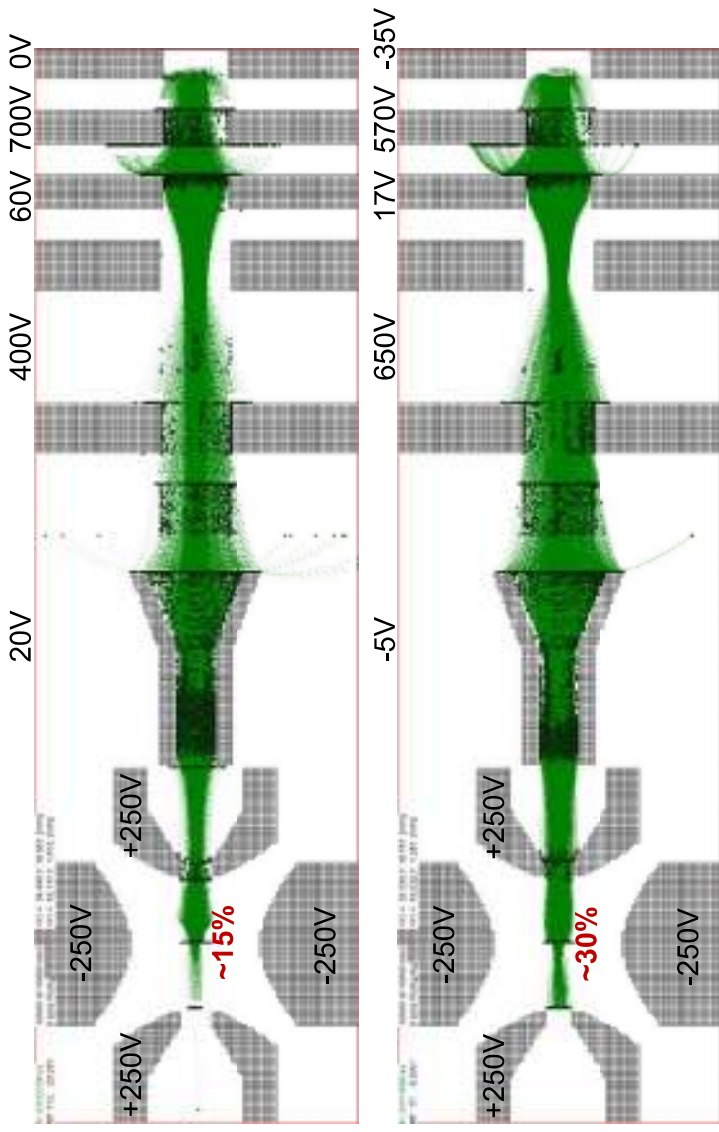

- electron optics simulations are performed for dense electron beams
- space charge effects are taken into account for an electron current of $40\mu\text{A}$
- electrode geometry was optimized for focusing electrons over an extended kinetic energy range

WP1 – Omnitrap & IMS development and testing

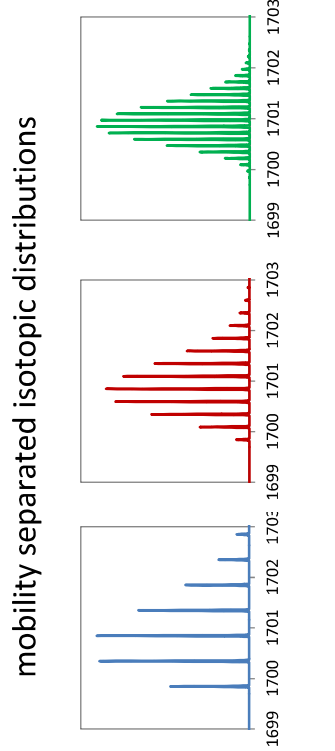
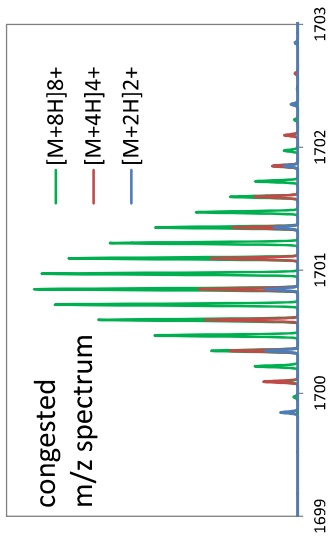
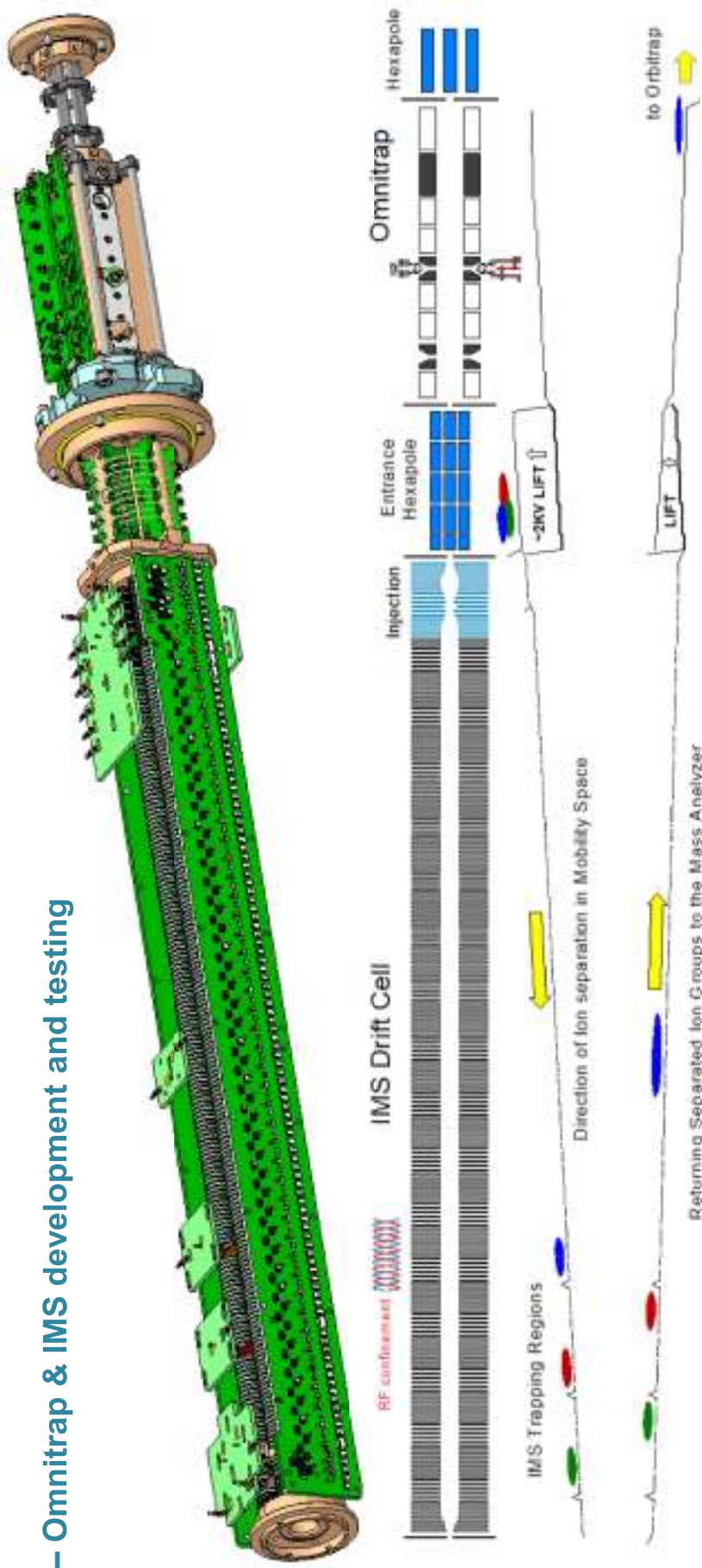

Top-Down
Spectral Complexity
Reduction

WP1 – Omnitrap & IMS development and testing

T1.1 – mech design & pulsed EI source

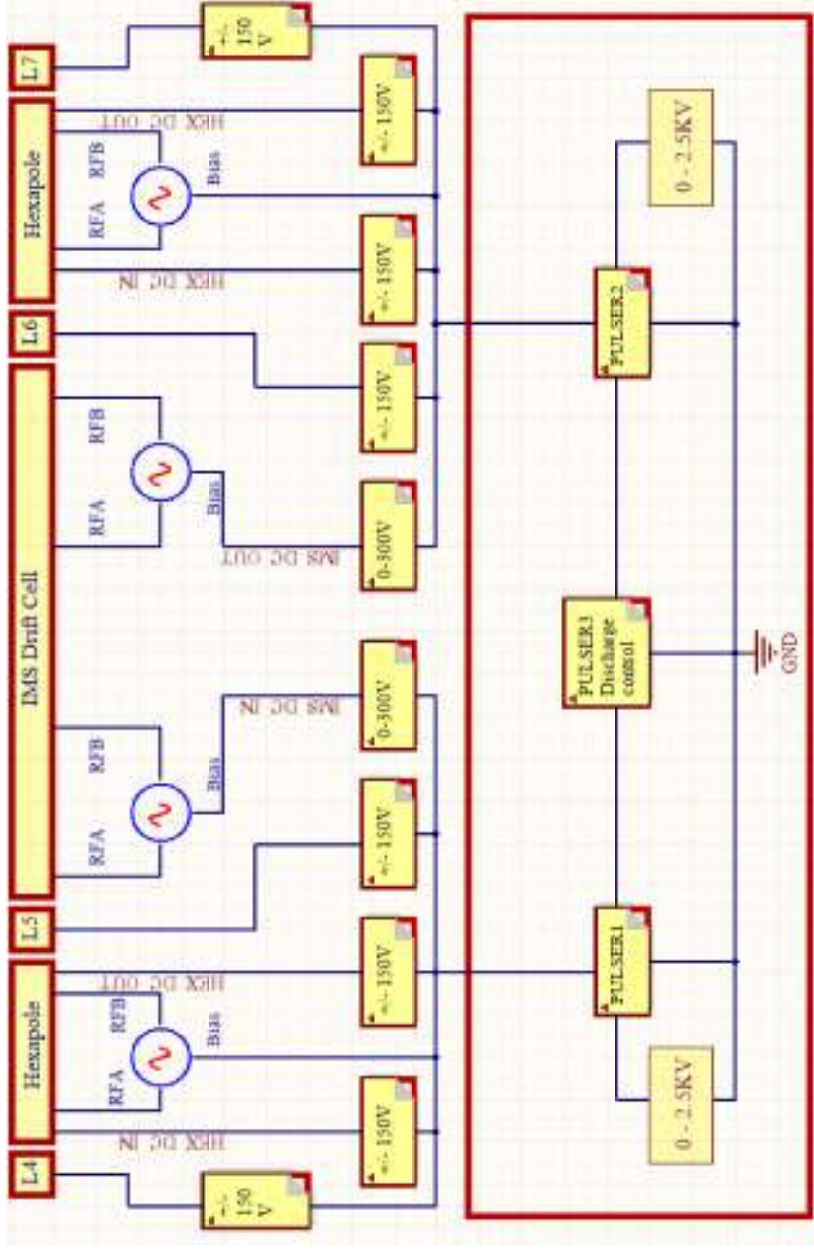

IMS Main Ctrl Board



IMS HV Pulsing Board



WP1 – Omnitrap & IMS development and testing

T1.1 – mech design & pulsed EI source

IMS Switch Board & Floating Switch Cards



Capacitor Bank



BN Gate Resistor Chain



Bipolar Switch Cards



Bipolar Switch Cards for BN Gate

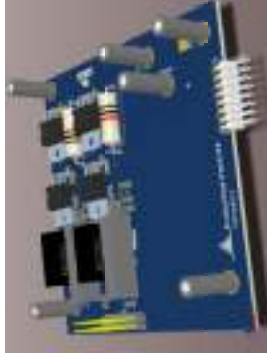

RF PSU & RF synch Unit

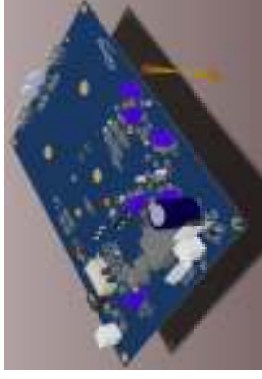

IMS Left RF-DC Distribution Unit



IMS Right RF-DC Distribution Unit



WP1 – Omnitrap & IMS development and testing

T1.1 – mech design & pulsed EI source

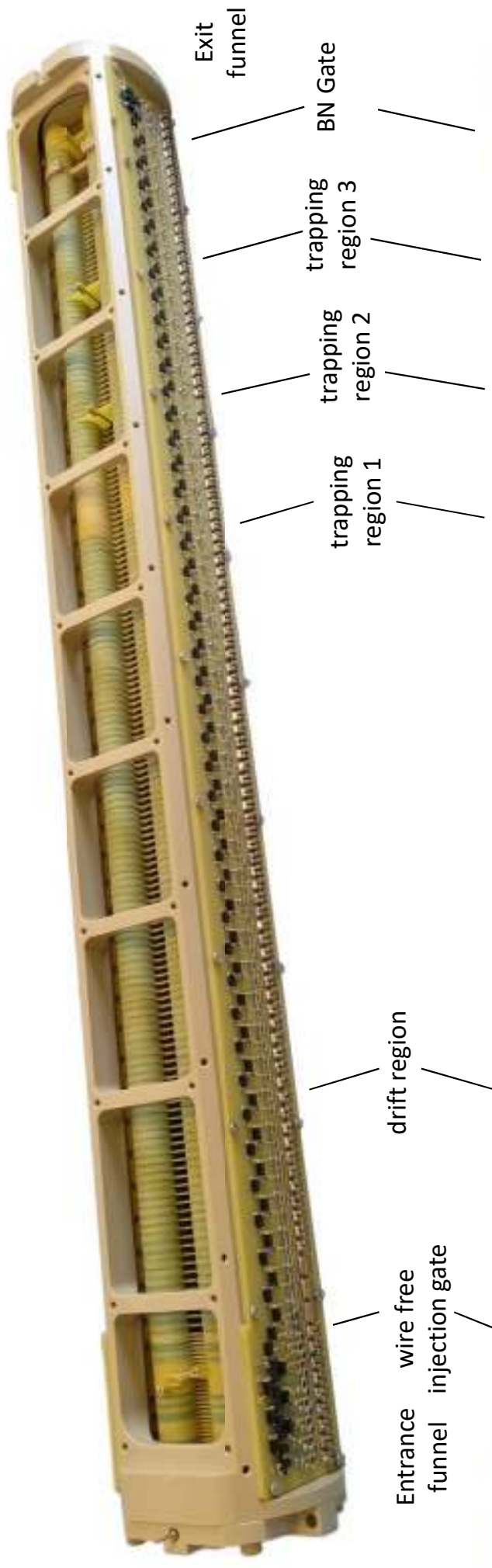

Ion Optics Simulations

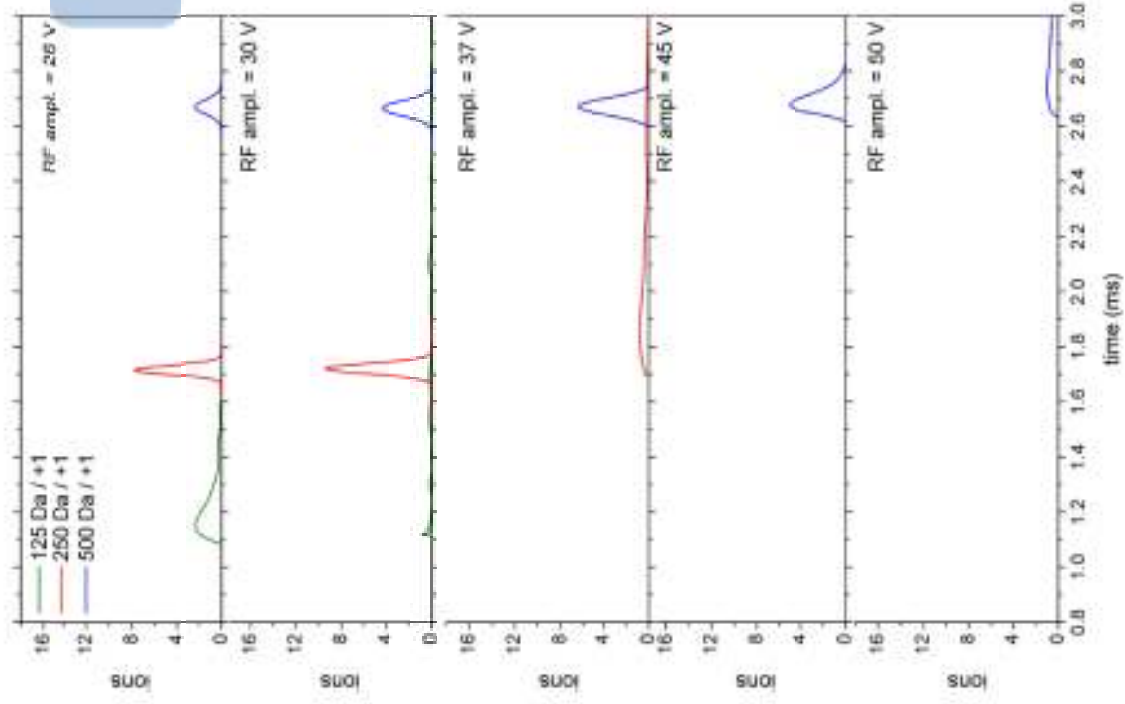
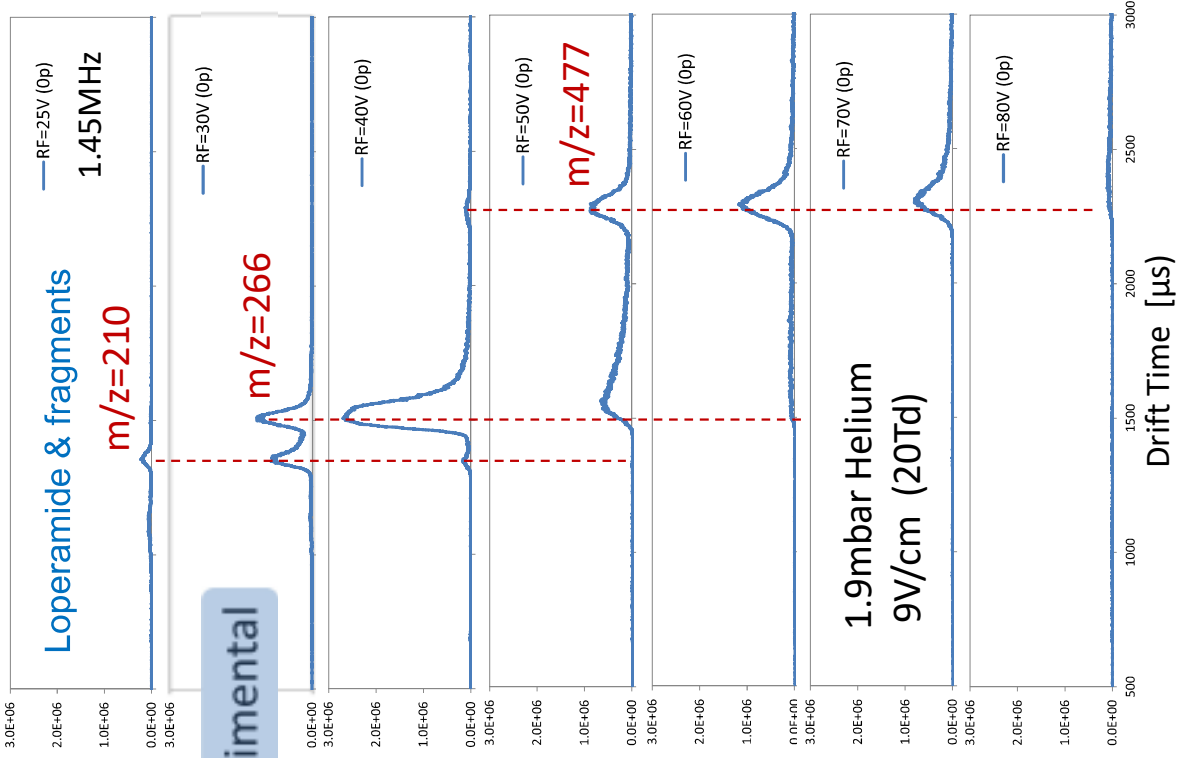

WP1 – Omnitrap & IMS development and testing

Variable DC Grad Across Drift Cell and Exit Funnel

IM:300V - F:100V RF:100V_{op} @ 1.5MHz 9.9 Td

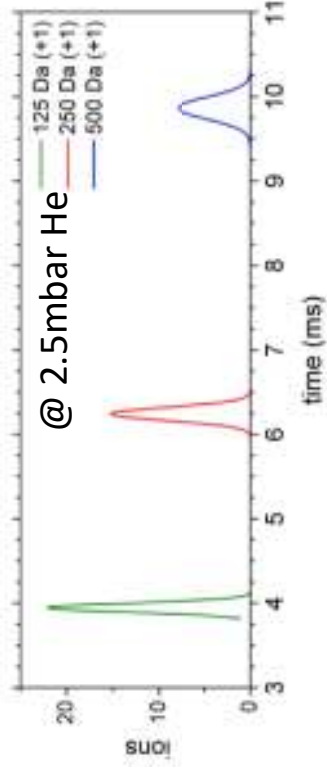

IM:200V - F:100V RF:100V_{op} @ 1.5MHz 6.6 Td

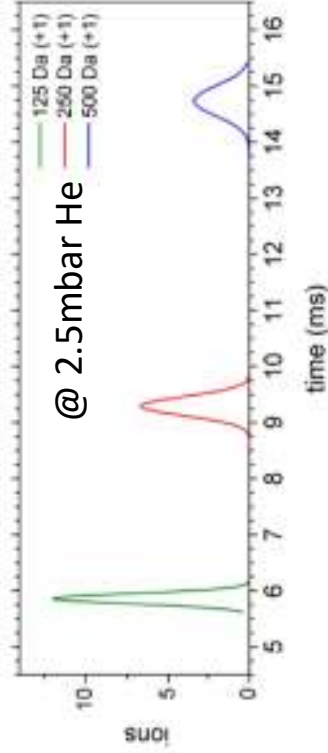

T1.1 – mech design & pulsed EI source

Mobility Separation of Ions with Coinciding m/z values

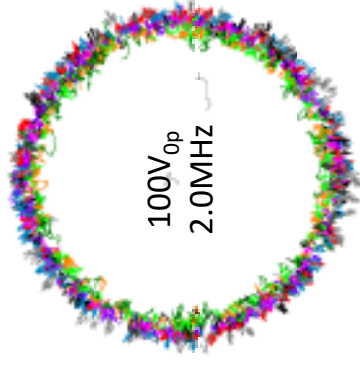
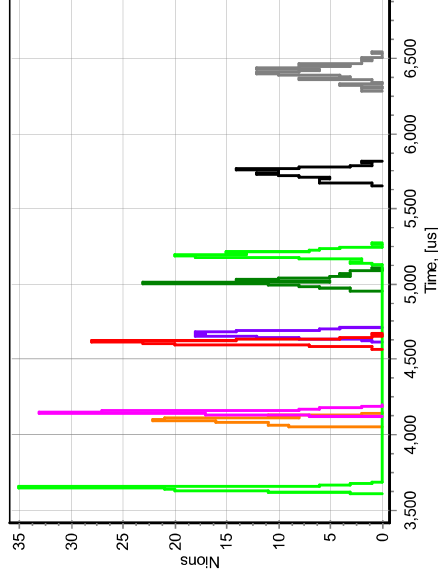
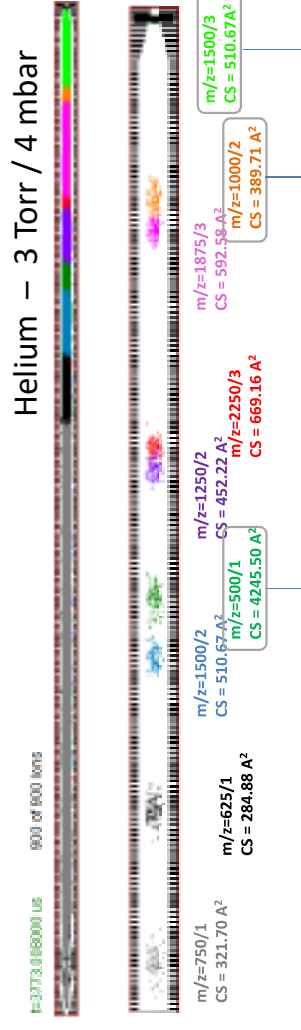

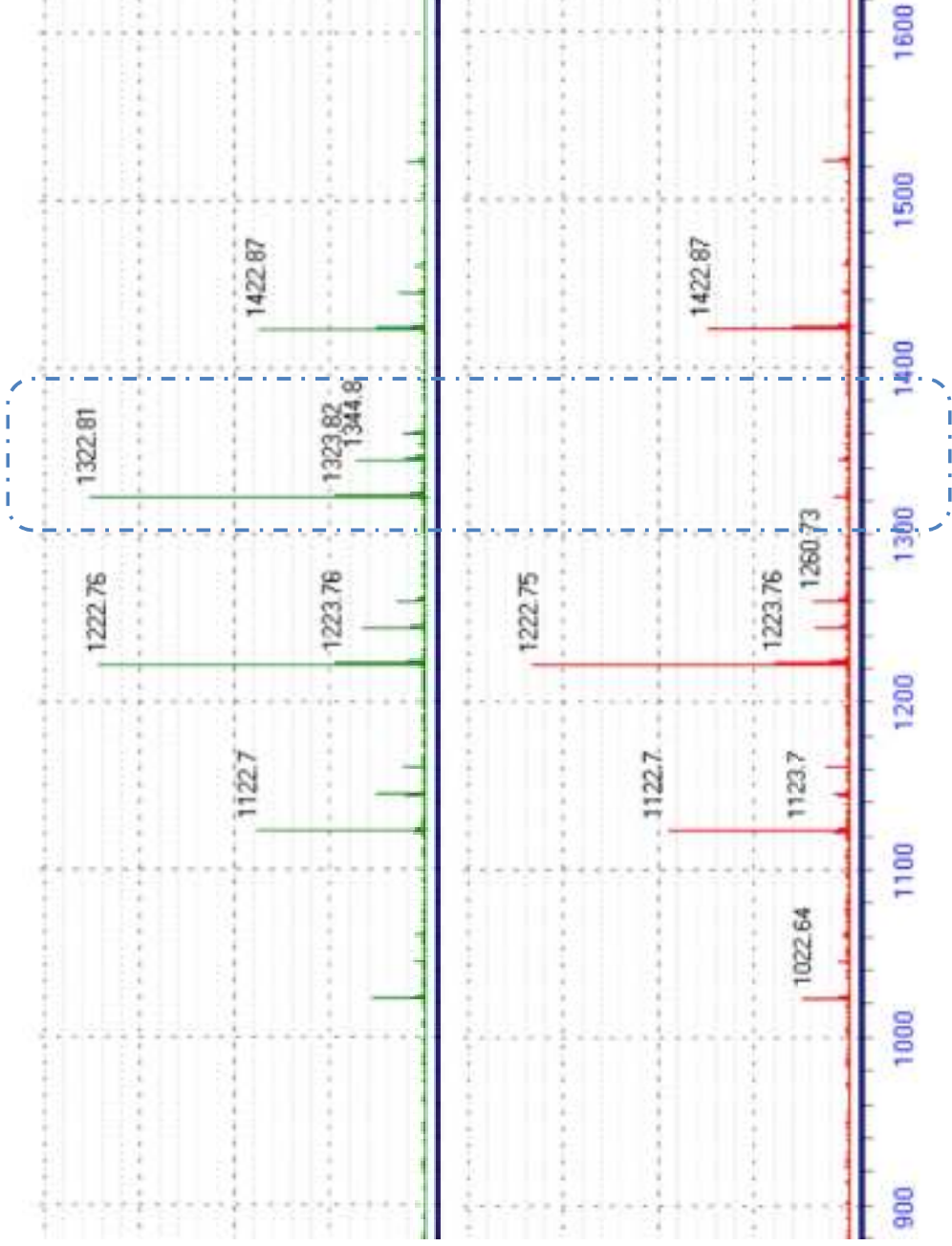

BN Gate Selection of Ion Bands

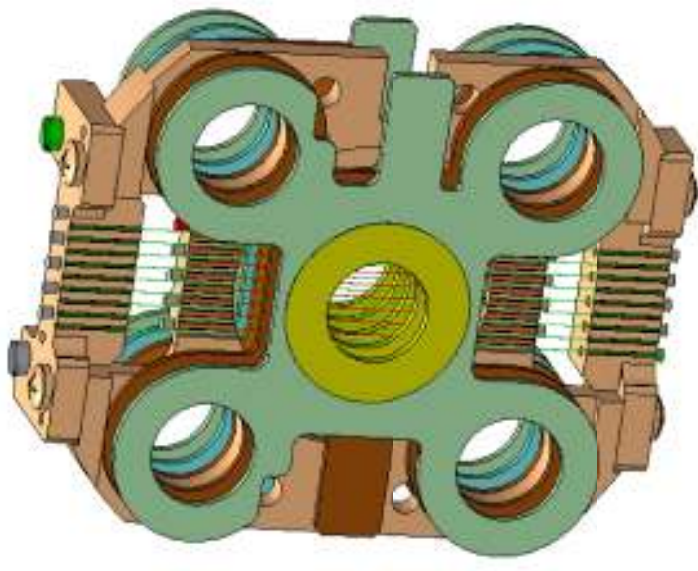

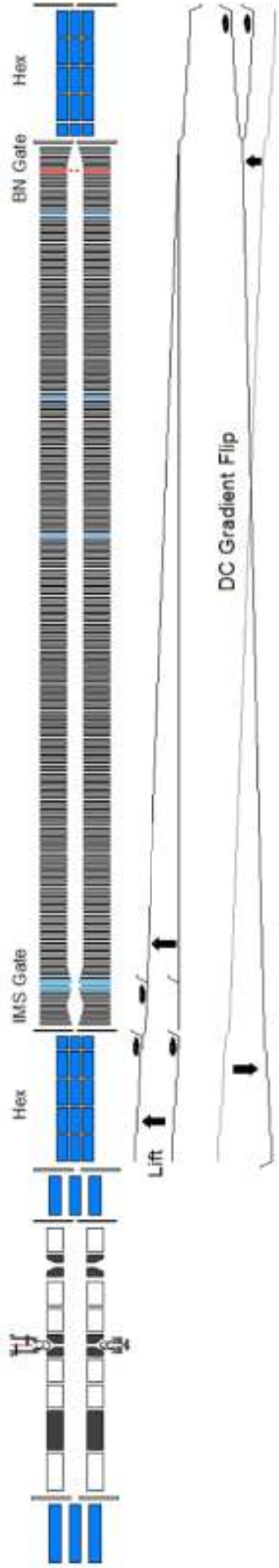

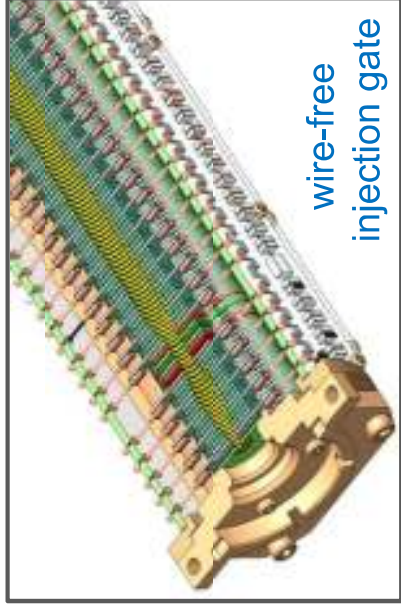

wire-free injection gate

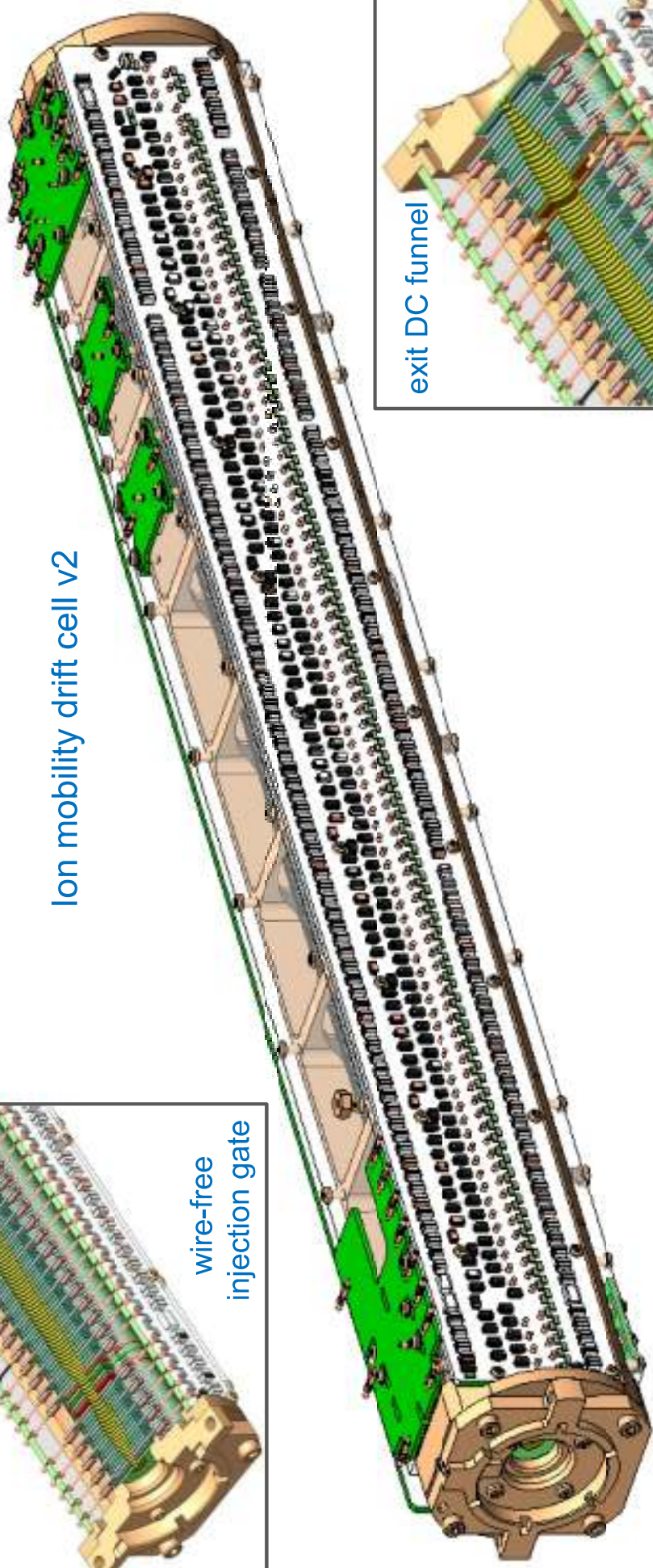

Ion mobility drift cell v2

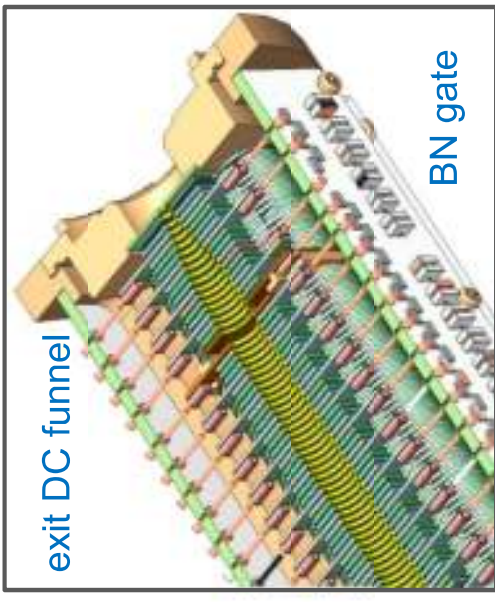

exit DC funnel

BN gate

WP1 – Omnitrap & IMS development and testing

T1.1 – mech design & pulsed EI source

Omnitrap IMS coupled to Exploris

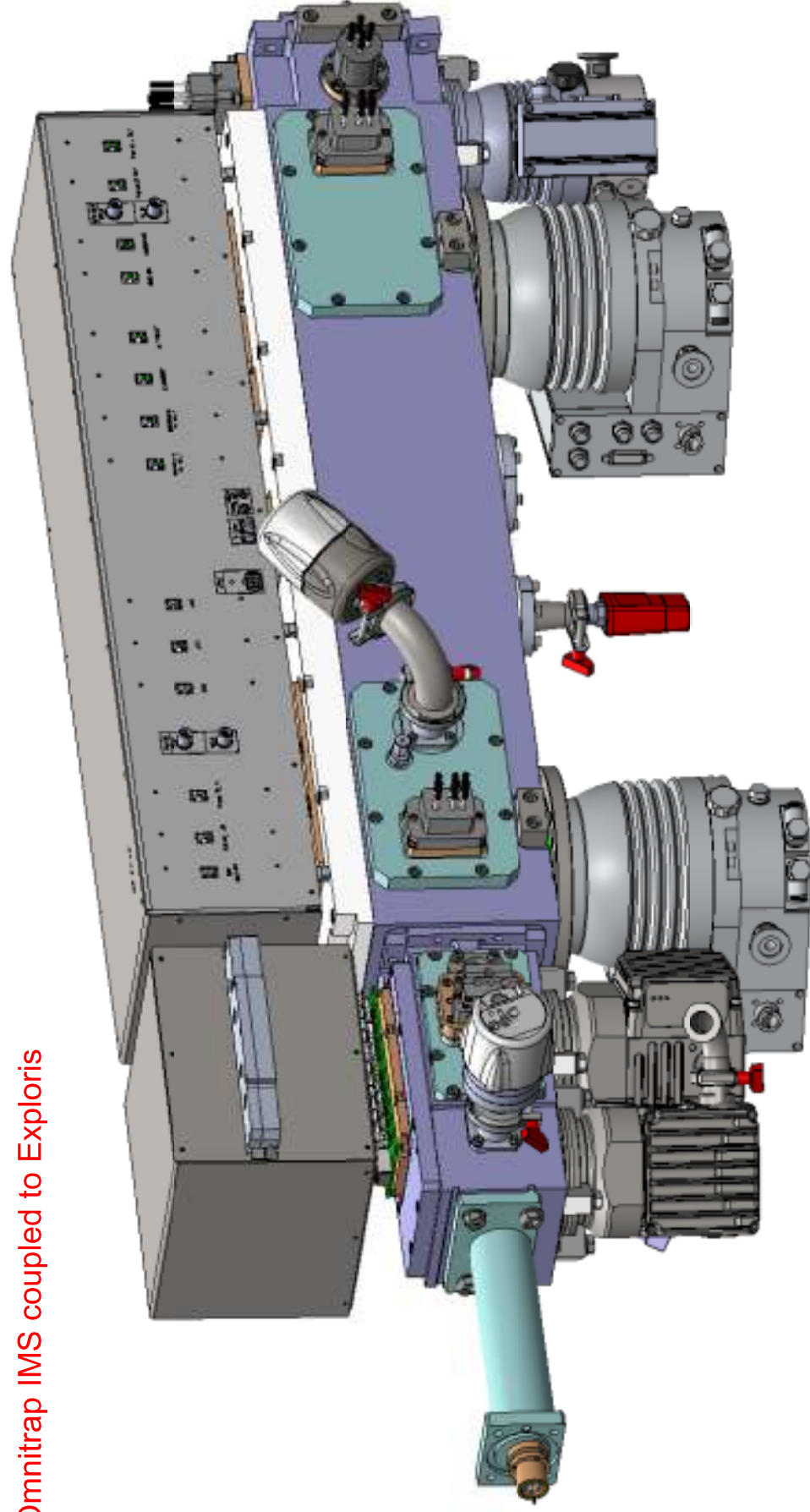

WP1 – Omnitrap & IMS development and testing

T1.1 – mech design & pulsed EI source

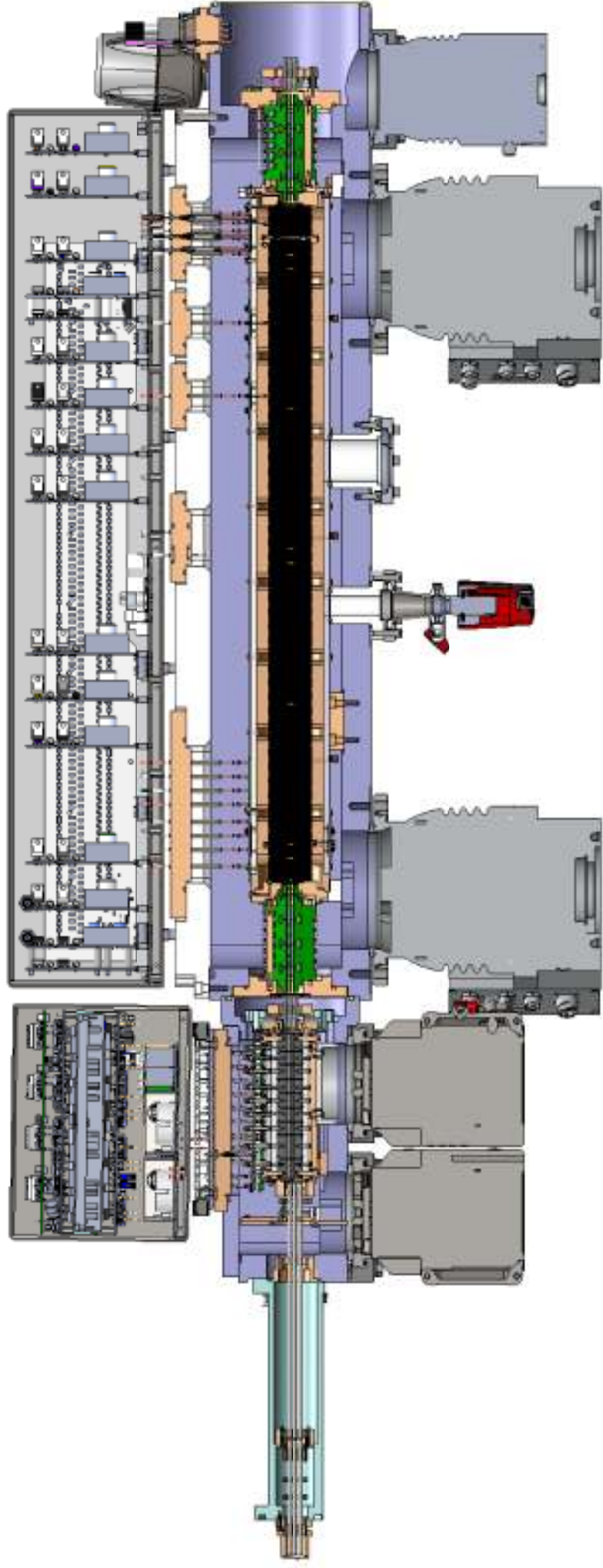

Omnitrap IMS coupled to Exploris

WP1 – Omnitrap & IMS development and testing

T1.1 – mech design & pulsed EI source

Omnitrap IMS coupled to Exploris

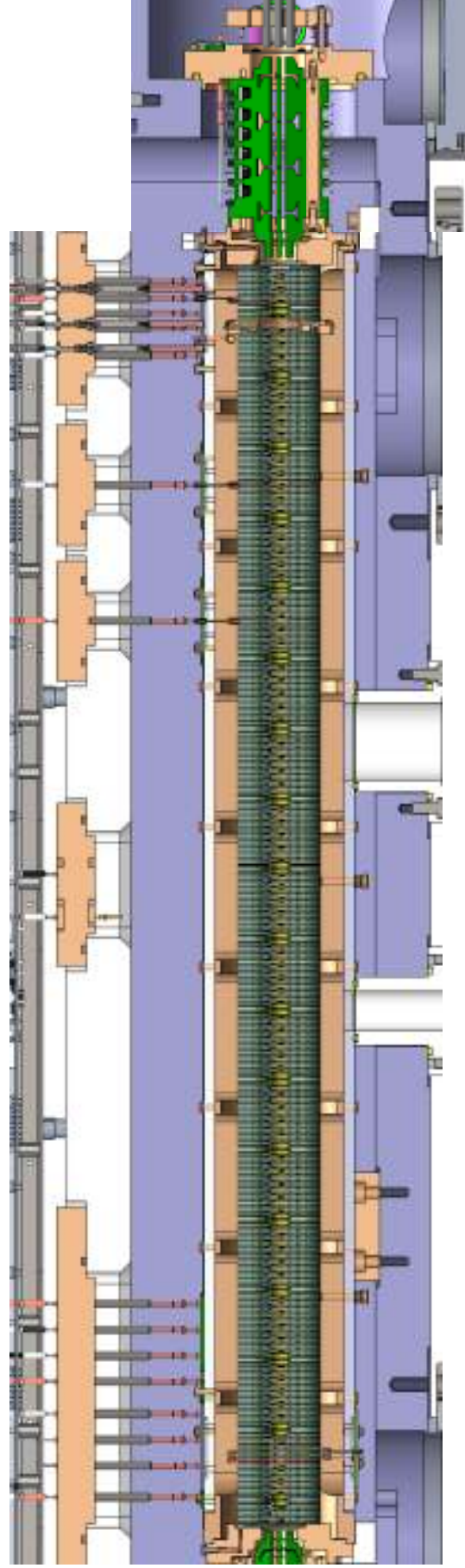
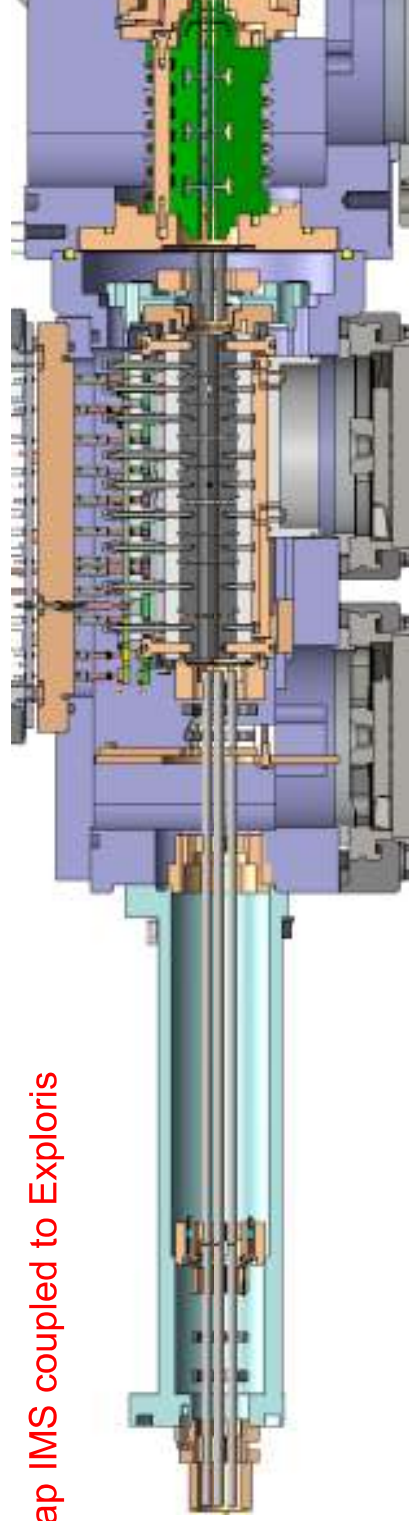

WP1 – Omnitrap & IMS development and testing

T1.2 – ion isolation simulation

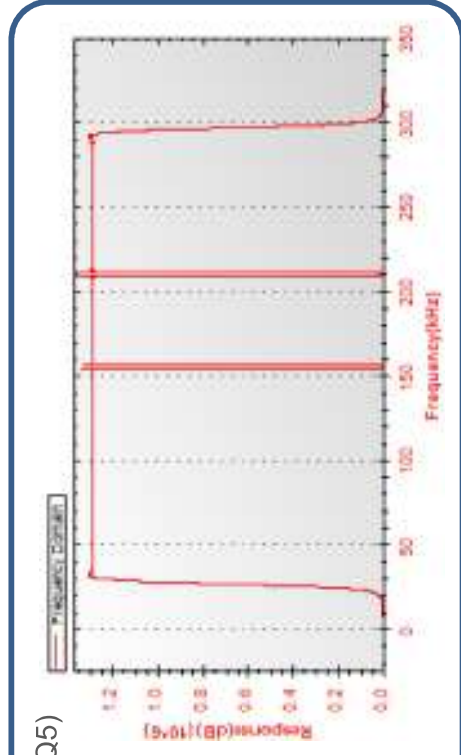
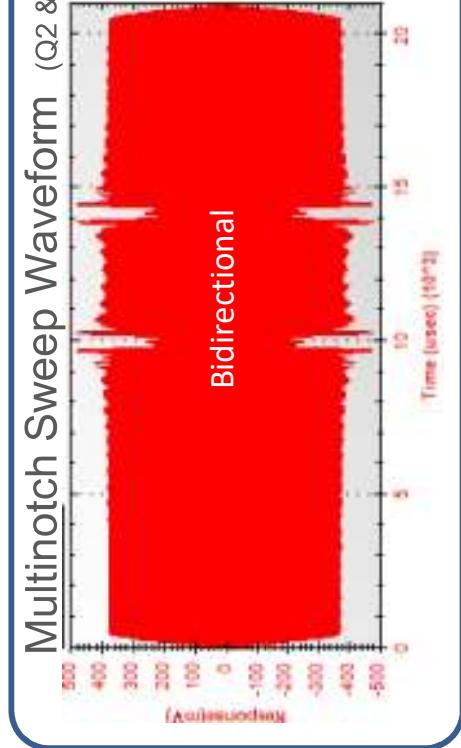
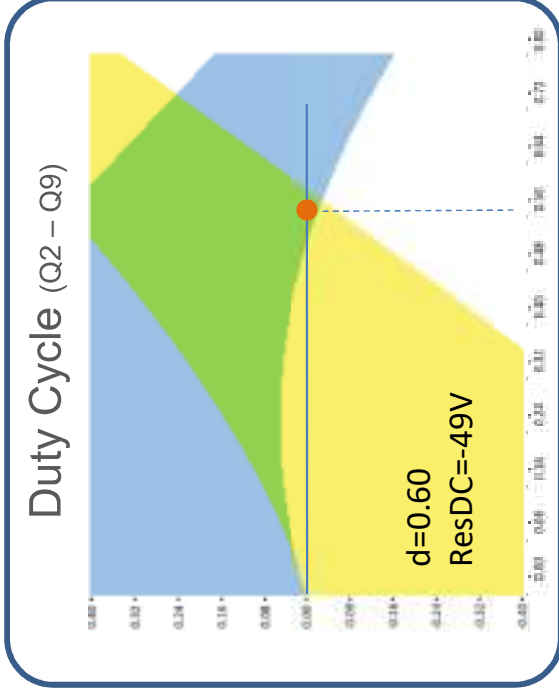
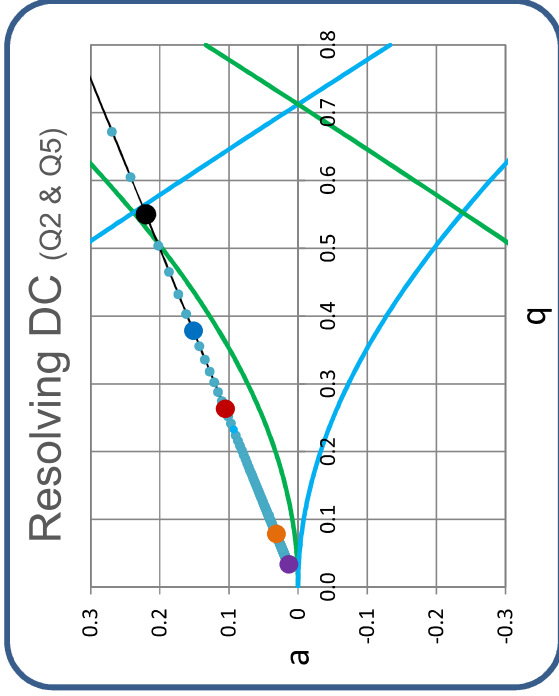

WP1 – Omnitrap & IMS development and testing

T1.2 – ion isolation simulation

Resolving DC Isolation

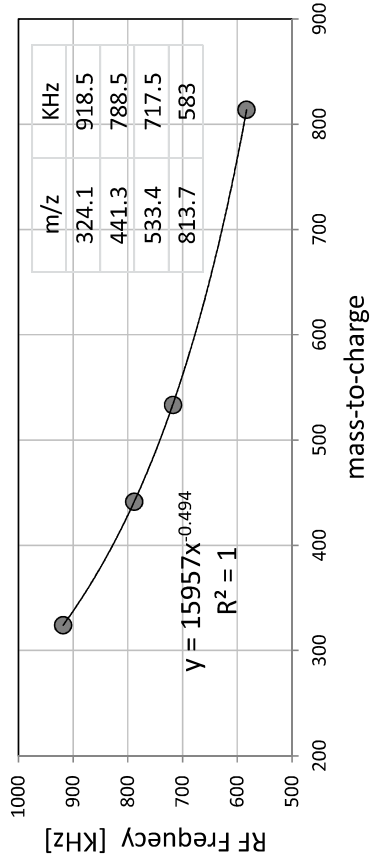
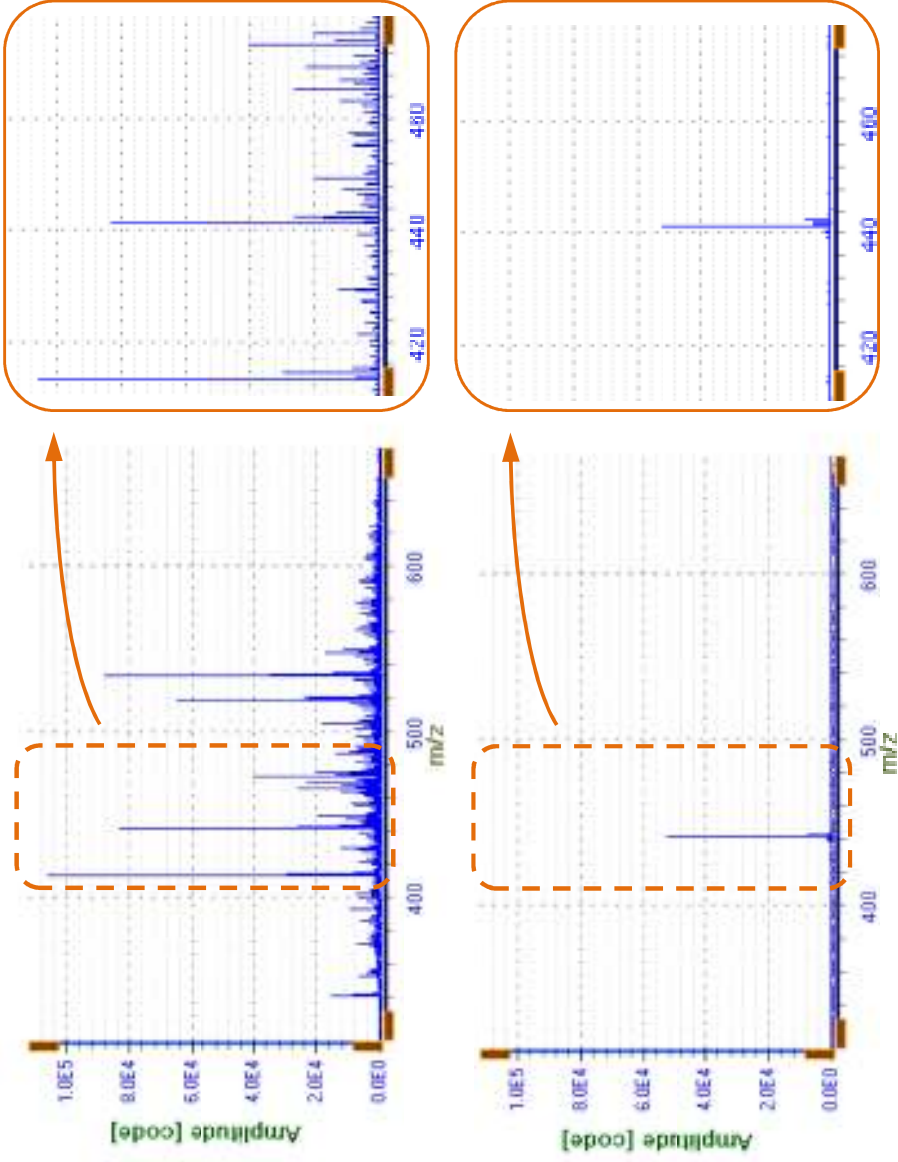
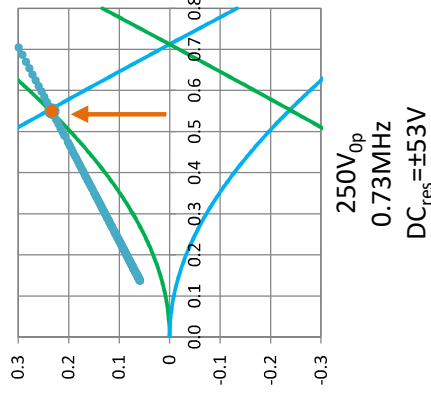
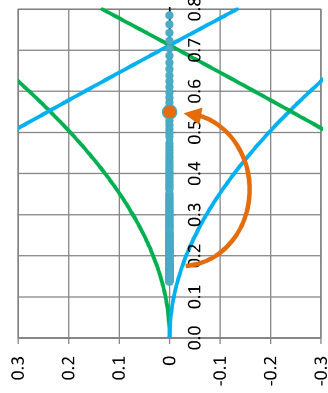

WP1 – Omnitrap & IMS development and testing

T1.2 – ion isolation simulation

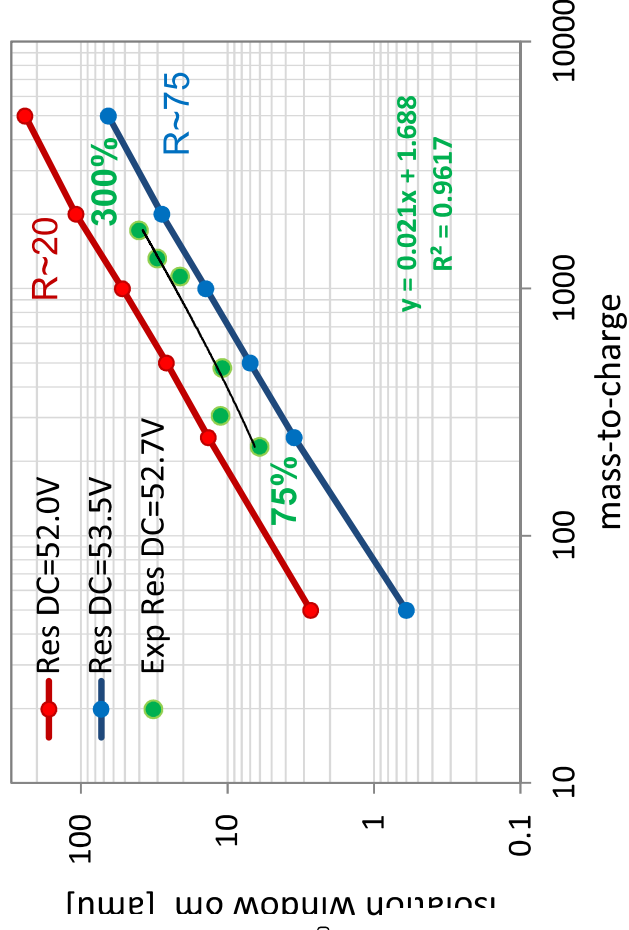
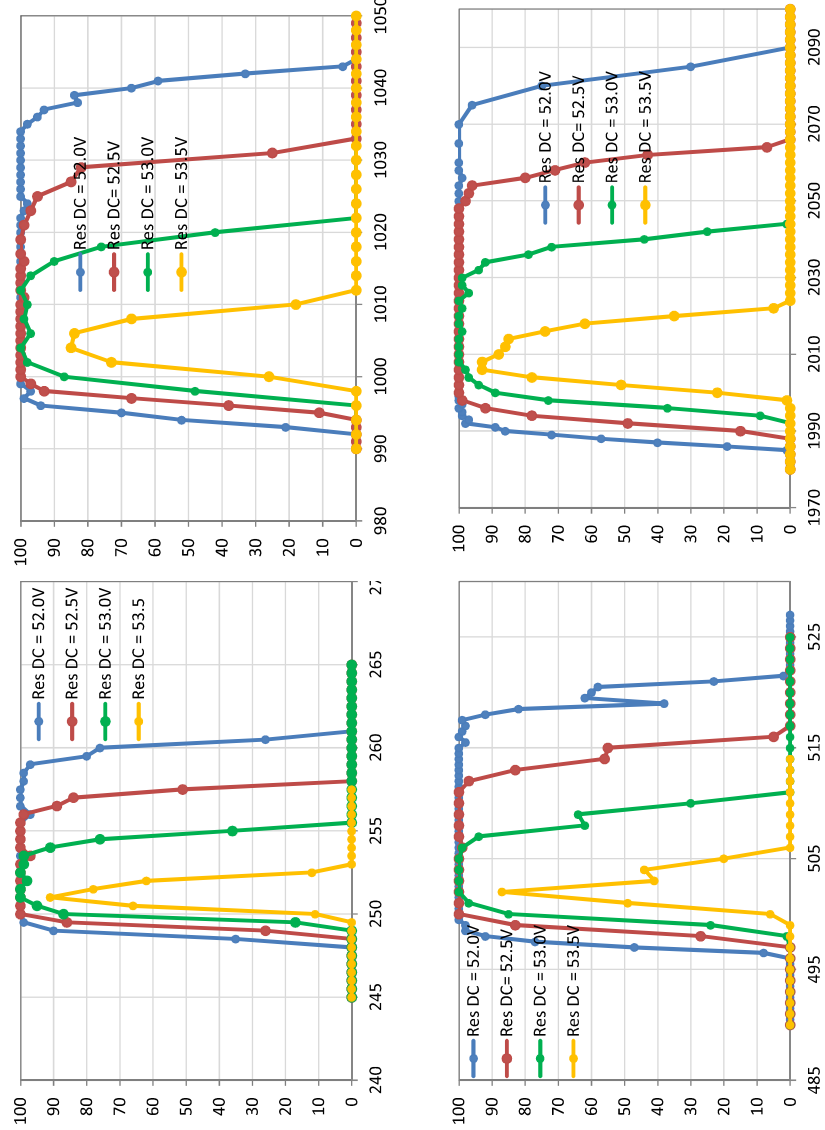

WP1 – Omnitrap & IMS development and testing

T1.2 – ion isolation simulation

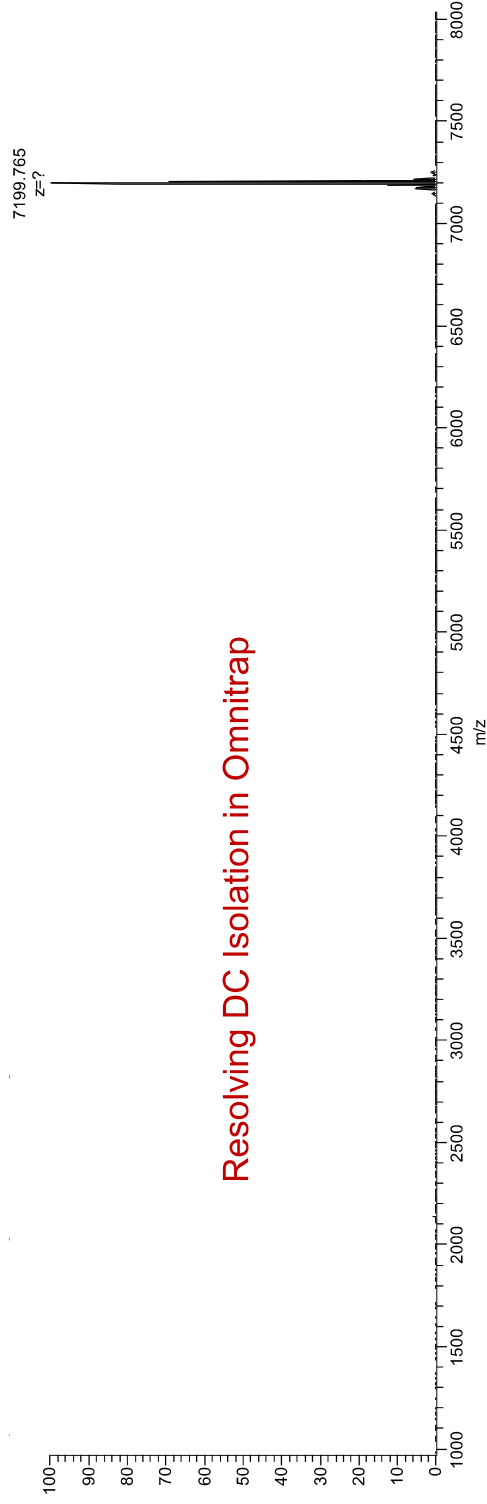
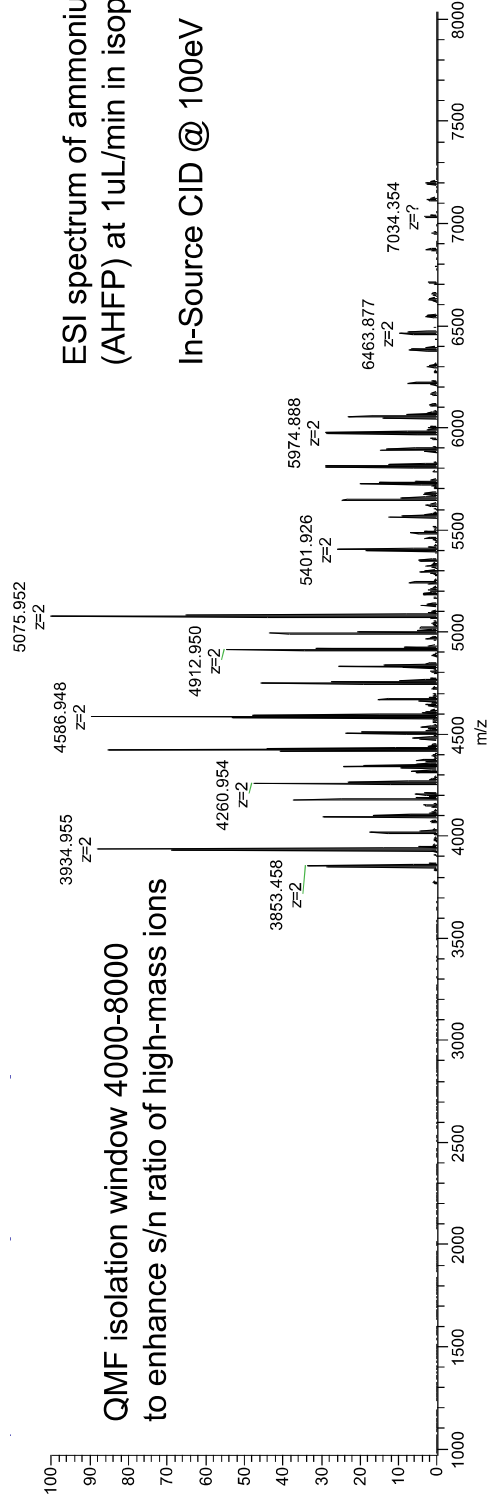

WP1 – Omnitrap & IMS development and testing

T1.2 – ion isolation simulation

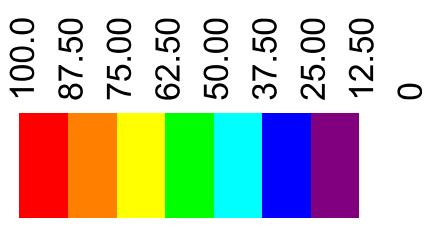
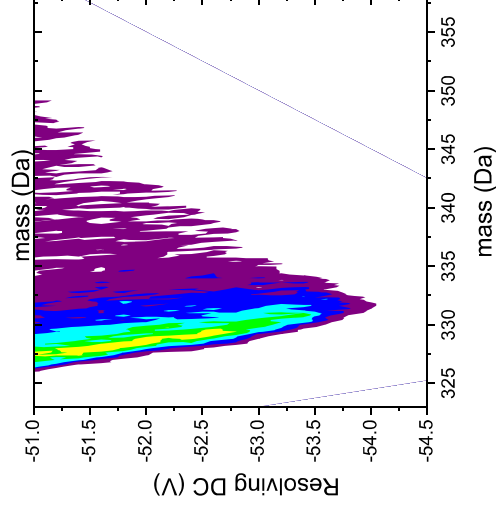
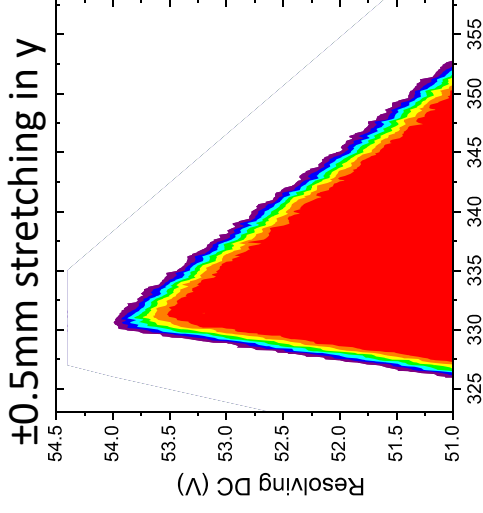
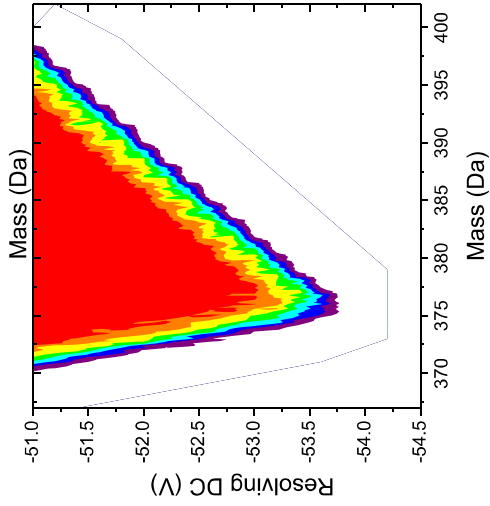
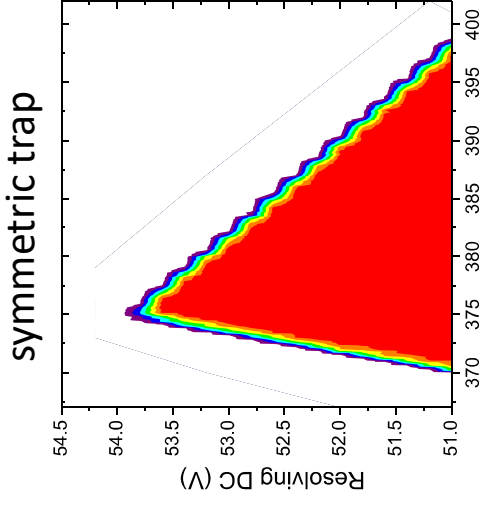
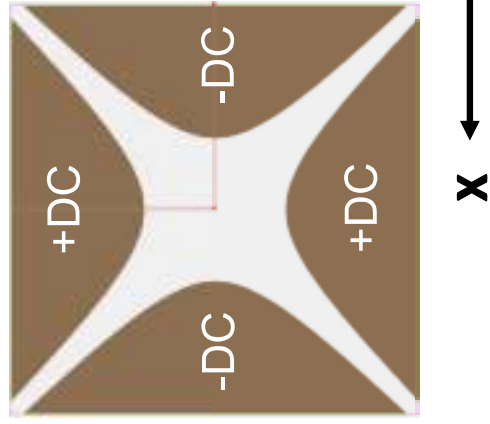
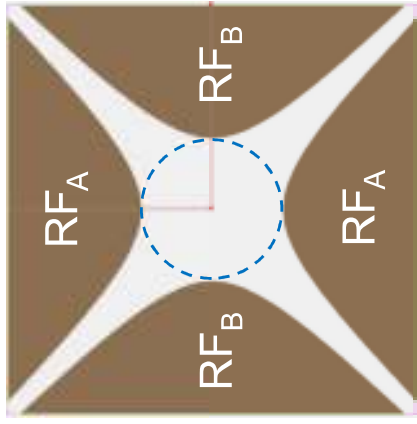

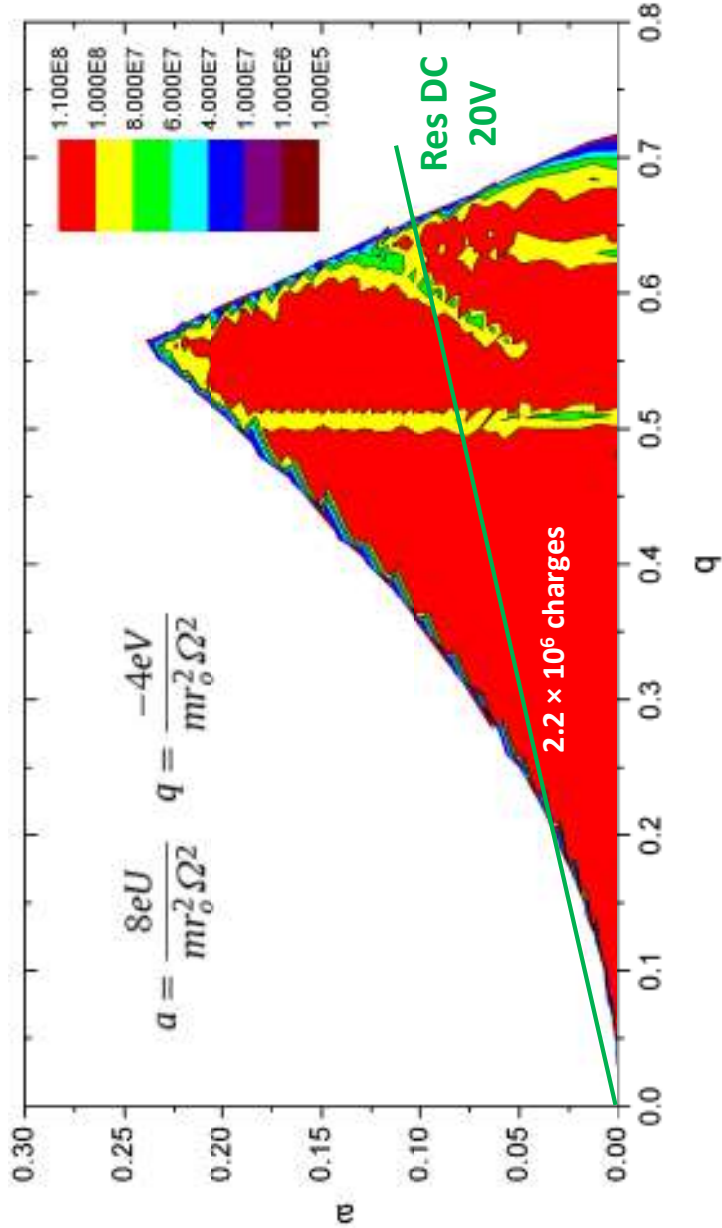

number of charges $z =$
 $= NL \times \text{Injection Time}$

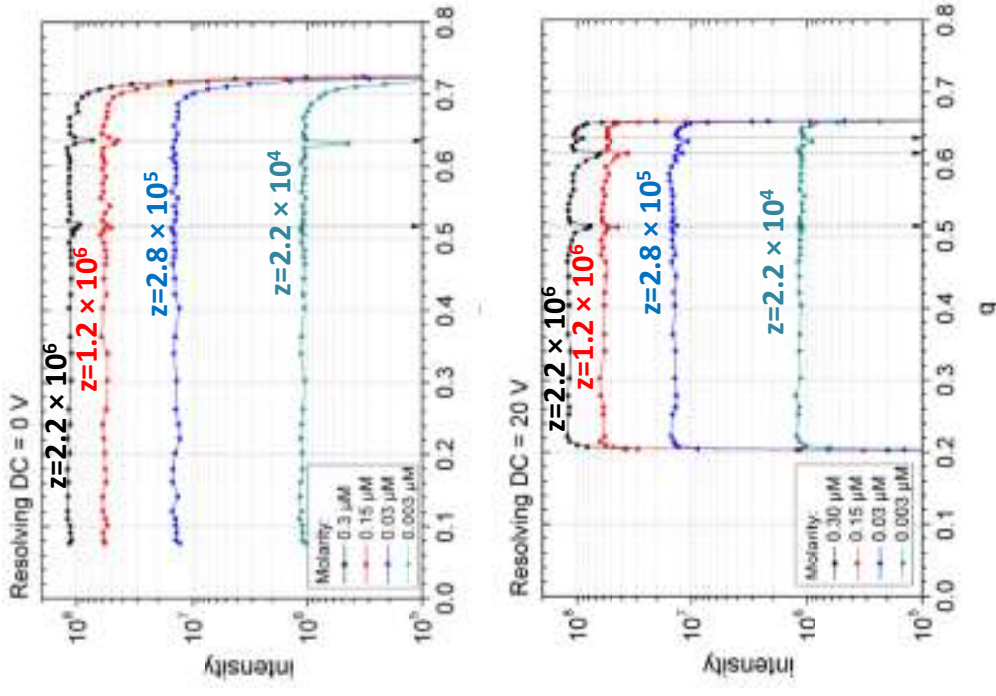

WP1 – Omnitrap & IMS development and testing

T1.2 – ion isolation simulation

RF: 725KHz – 250V_{op}
LMCO=388.5 r_o=4.1mm

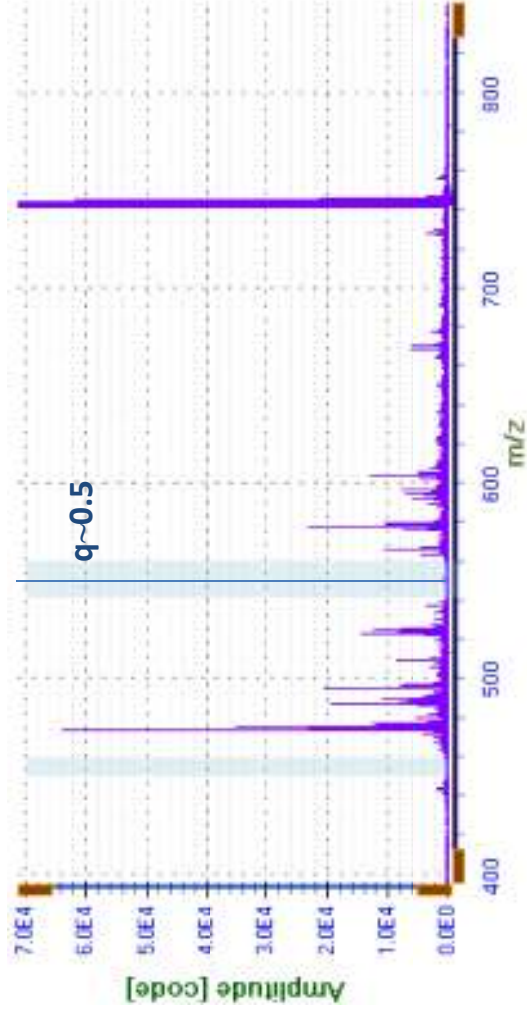

25ms injection window

100pA – 15M charges

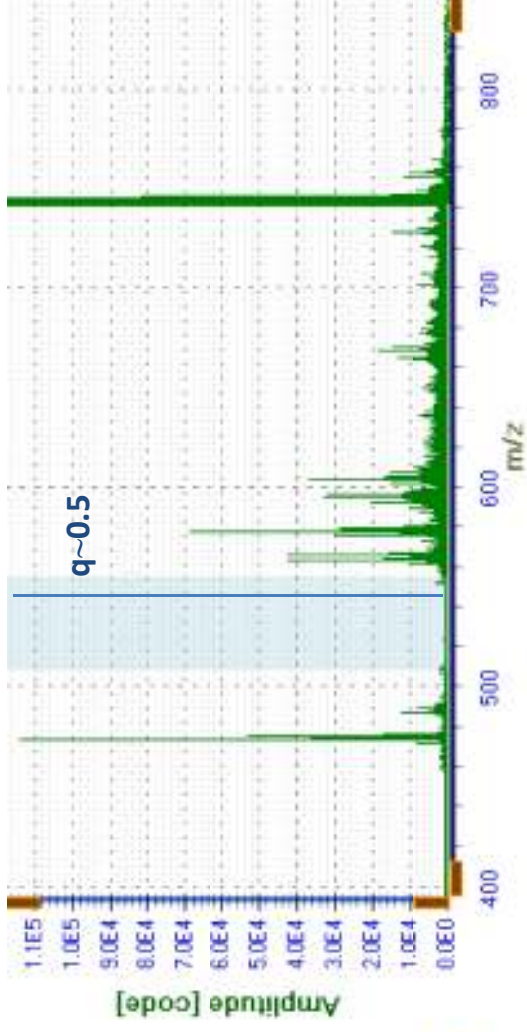

50ms injection window

100pA – 30M charges

WP1 – Omnitrap & IMS development and testing

T1.3 – rect RF Generator

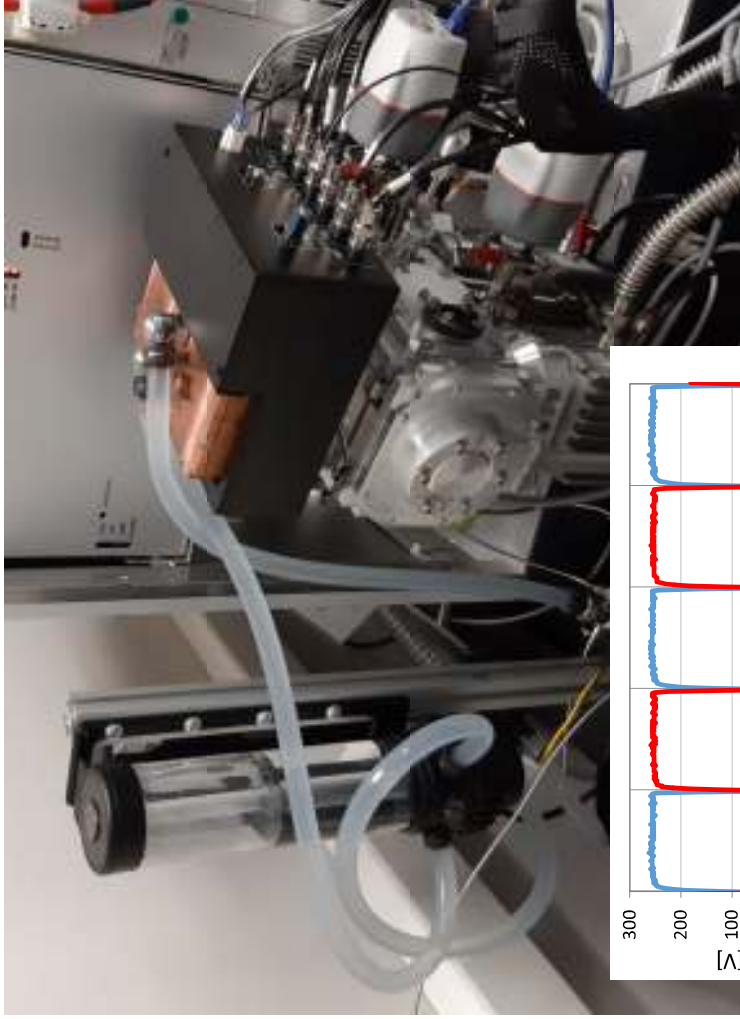

250V_{op}
1000KHz

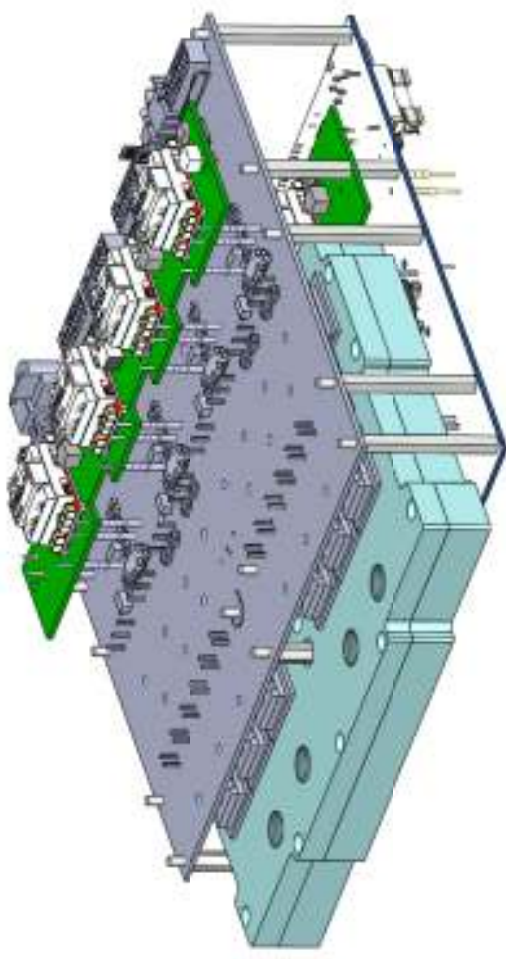
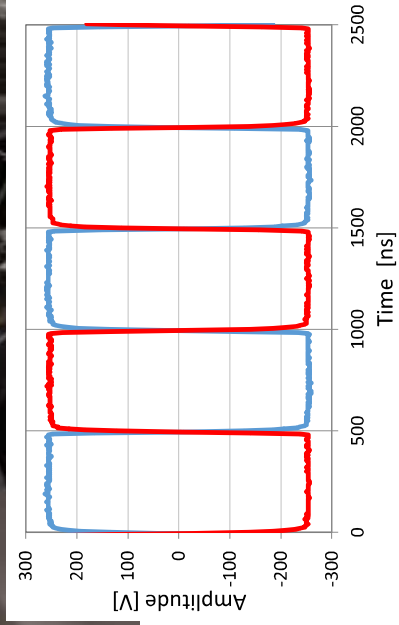

400V_{op} rectangular RF
generator v3

WP1 – Omnitrap & IMS development and testing

T1.4 – assembly of omni's & ims

JUL '20



omnitrap parts received
assembly scheduled for February-end
ordering is still underway

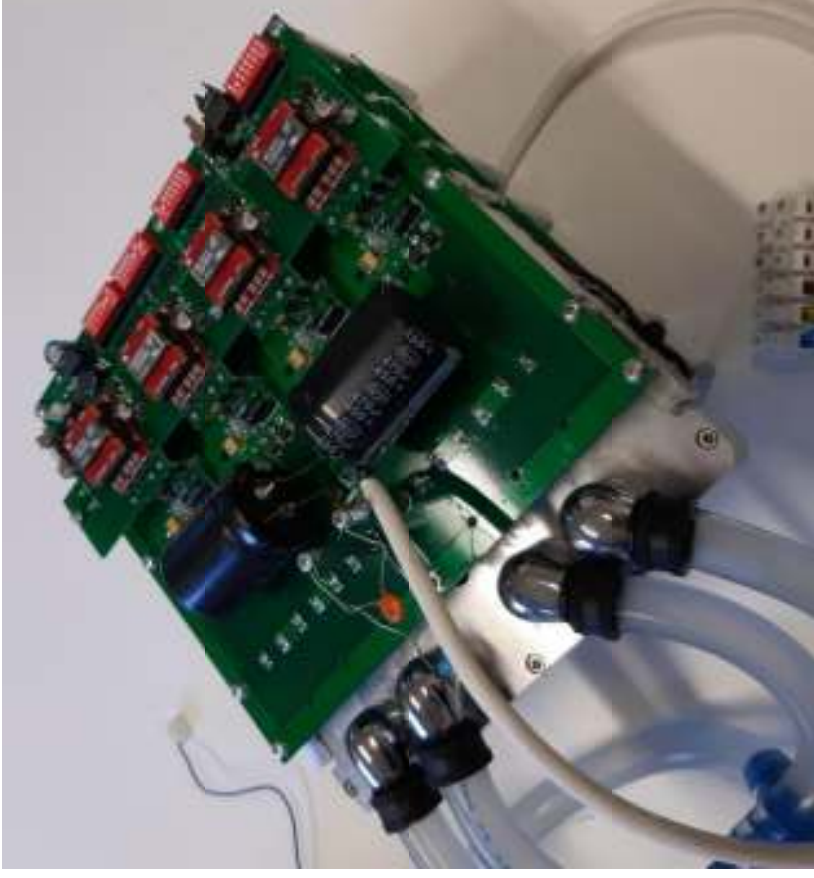

400V_{op} rectangular RF
generator v3

WP1 – Omnitrap & IMS development and testing

T1.4 – assembly of omni's & ims

JUL '20



IMS outer & inner housing, drift pcb-electrode assembly, vacuum pcb's and electronics circuitries

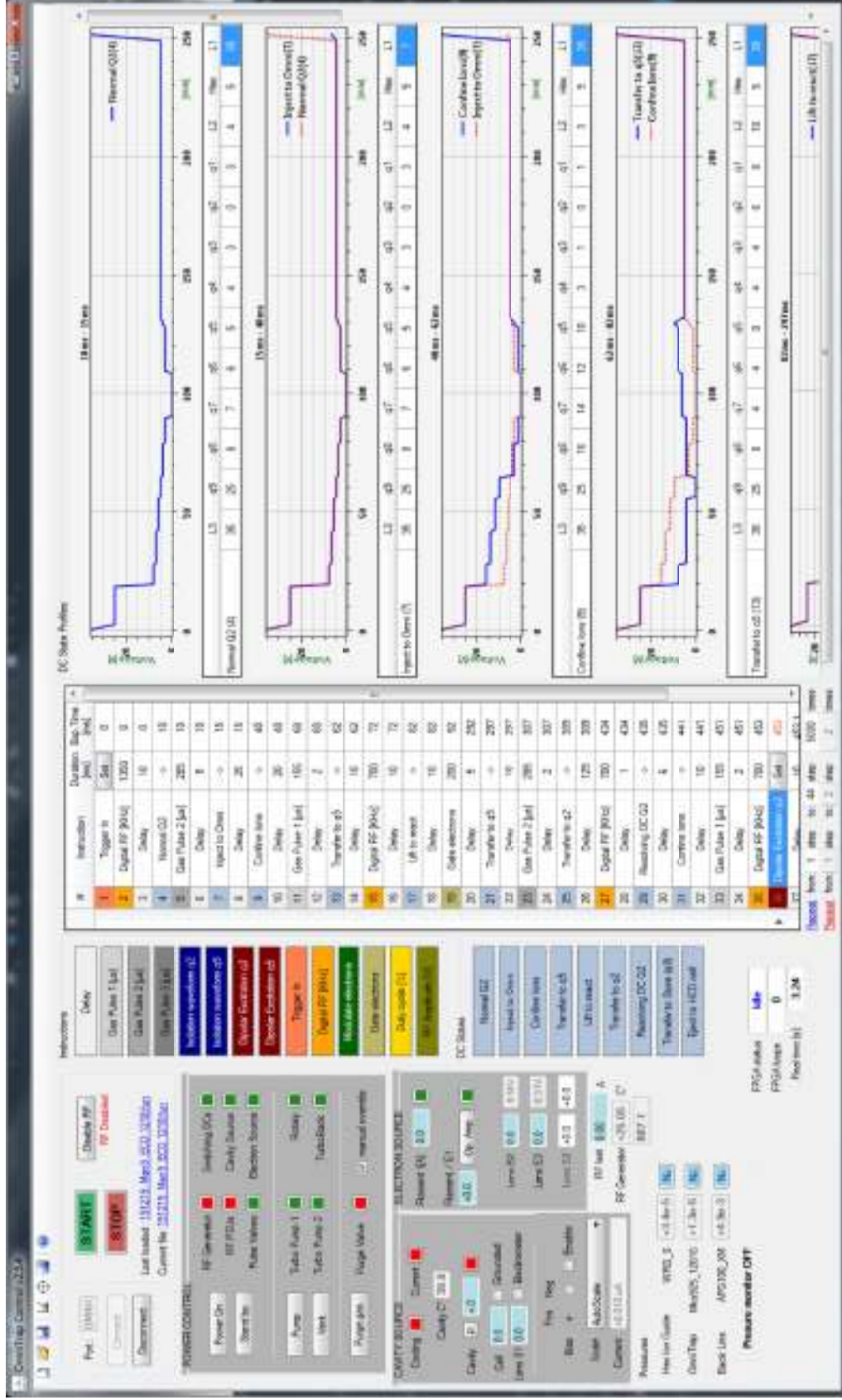



Omnitrapp

- 250V_{op} Rectangular RF Generator
- FPGA Unit
- Multi-level DC Switch
- Uart Hub (PC-electric communication)
- Electron Source Unit
- Hydrogen Atom Source Unit
- Pulse Valves
- High Voltage PSUs

Power Unit

IMS Drift Cell

- IMS DC Pulsing & Floating DCs
- Floating DC Switch Array Unit
- Sin RG Generator & RF Driver synchronisation



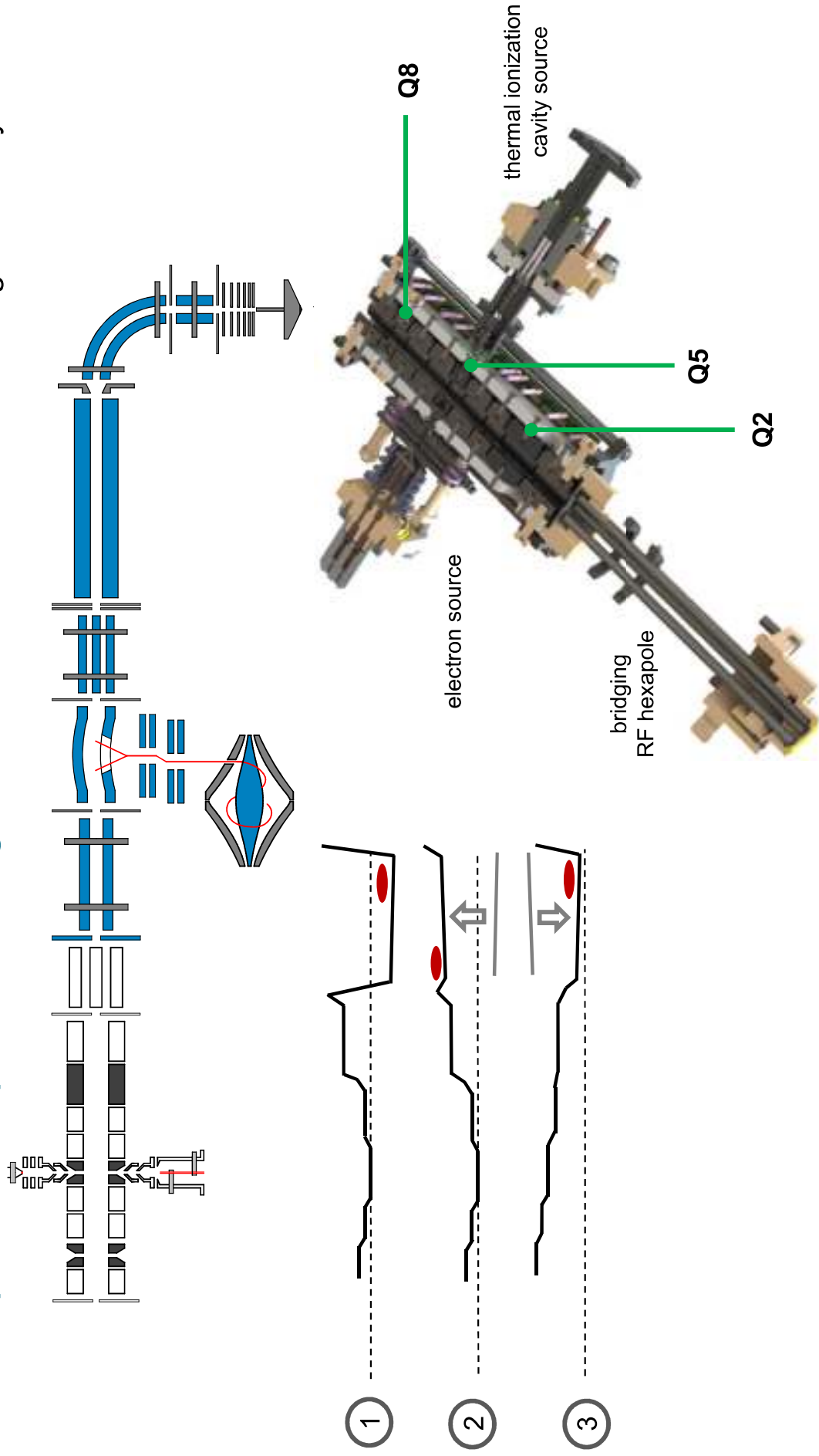

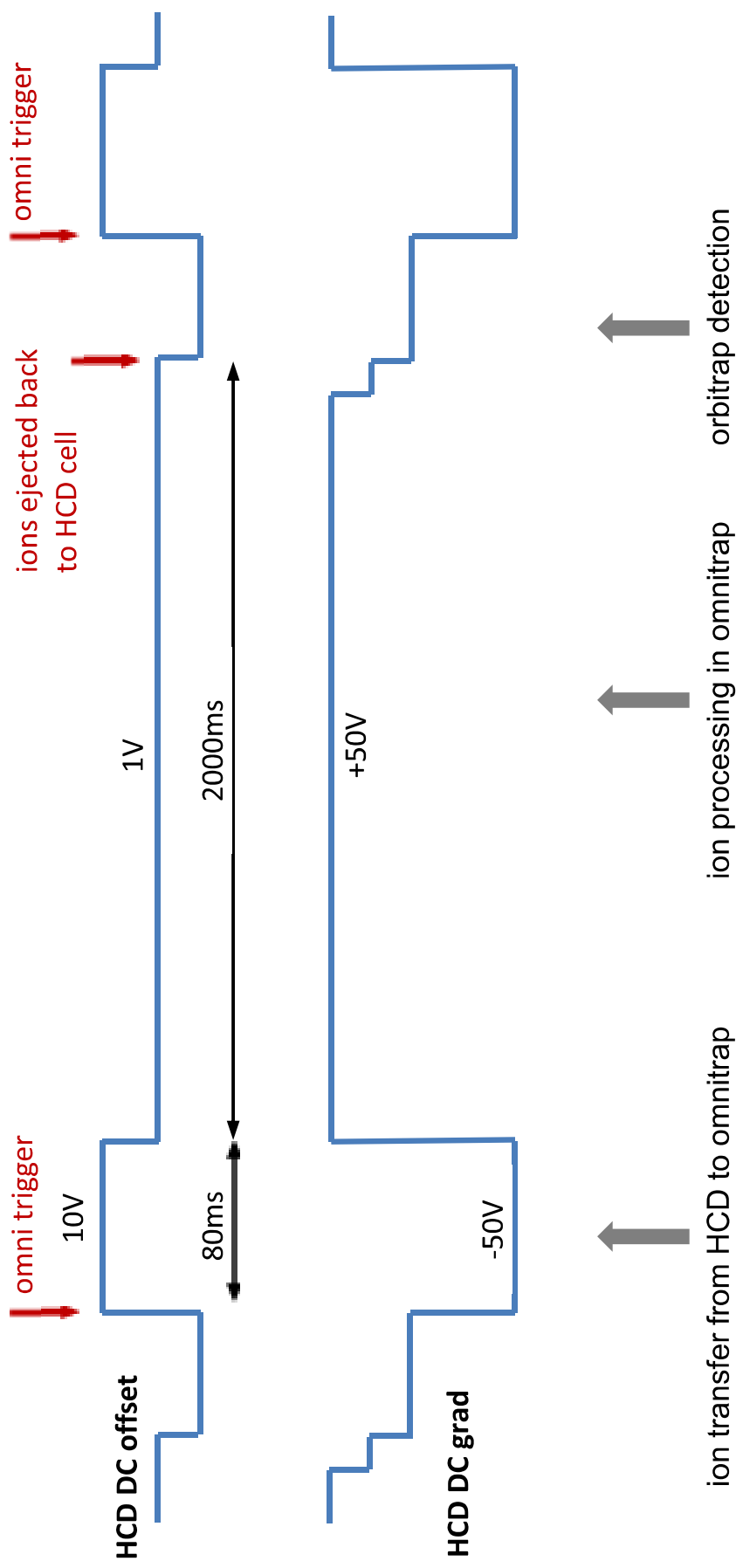

Omnitrap Instrumentation Development Overview

	Design	Assembly	Tests	Revisions
	<ul style="list-style-type: none"> ✓ Omnitrap ✓ IMS drift cell ✓ Electronics ✓ Software 	<ul style="list-style-type: none"> ✓ Omnitrap ✓ IMS drift cell ✓ Electronics ✓ Software 	<ul style="list-style-type: none"> ✓ Omnitrap ✓ IMS drift cell ✓ Electronics ✓ Software 	<ul style="list-style-type: none"> Electron Source Thermal H• Source Hyperthermal H• Source Software Updates

Omnitrap-IMS QE HF

<ul style="list-style-type: none"> ✓ Omnitrap ✓ IMS drift cell ✓ Electronics ✓ Software 	<ul style="list-style-type: none"> ✓ Omnitrap ✓ Electronics ✓ Software
---	---

Omnitrap-IMS Exploris

Omnitrap QE HF

