



H2020 Programme

Periodic Technical Report – Part B

Project number: 829157

Project Acronym: TopSpec

Project Title: *Next generation precision antibody profiling - from science fiction to reality*

Period covered by the report: from 01/01/2019 to 31/01/2020

Periodic report: 1st.

Table of content:

1. Explanation of the work carried out by the beneficiaries and Overview of the progress:	
1.0 Introduction.....	3
1.1 Objectives.....	6
1.2 Explanation of the work carried out per WP.....	10
1.2.1 WP1.....	10
1.2.2 WP2.....	17
1.2.3 WP3.....	26
1.2.4 WP4.....	29
1.2.5 WP5.....	31
1.2.6 WP6.....	35
1.2.7 WP7.....	37
1.2.8 WP8.....	53
1.2.9 WP9.....	58
1.3 Impact	
1.3.1 Impact on technology and society.....	62
2. Update of the plan for exploitation and dissemination of results.....	62
3. Update of the data management plan.....	62
4. Follow up recommendations and comments from previous review(s).....	62
5. Deviation from Annex 1 and Annex 2.....	62
5.1 Tasks.....	62
5.2 Use of resources.....	62
5.2.1 Unforeseen subcontracting.....	62
5.2.2 Unforeseen use of in kind contribution from third party against payment of free of charges.....	63

1. Explanation of the work carried out by the beneficiaries and Overview of the progress:

Four out of five milestones of the first year have been reached and the deliverables delivered in time. The following is a summary of the executed deliverables and milestones in chronological order:

Deliverables:

D9.1: Logo and Website launch and public accessibility. Deadline: 28/2–2019; Delivered: 28/2–2019.

D8.1: IP protection strategy finalized. Deadline: 31/3–2019; Delivered: 29/3–2019.

D9.2: Data management plan. Deadline: 30/6–2019; Delivered: 28/6–2019.

D6.1: Modification of the Orbitrap mass spectrometer. Deadline: 31/12–2019; Delivered: 20/12–2019.

D8.2: Exploitation and Dissemination Plan. Deadline: 31/12–2019; Delivered: 20/12–2019.

Milestones:

M1. Demonstrated effectiveness of product ion isotopic distribution deconvolution (WP7). Achieved.

M2. Omnitrap & IMS Electronics design (WP1). Achieved.

M3. Installation of Q Exactive instrument for Omnitrap development (WP6). Achieved.

M4. Omnitrap & IMS P.O.s sent to suppliers. Ongoing - finalized Jan/Feb 2020.

M5. Omnitrap & IMS Mechanical design (WP1). Achieved.

Successful developments on all aspects of the TopSpec platform have been realized and a comprehensive summary of the work in progress is provided. Achievements, delays, drawbacks and risk mitigation strategies are highlighted. The complex hardware developments related to the omnitrap sub-platform are satisfactory with high quality top down spectra of antibodies being generated. However, considerable effort is required to optimize the exceptionally wide versatility of the device.

Overall, the TopSpec platform integrates the following sub-platforms, **Figure 1:** (i) a pl-trap for sample separation prior to the introduction into a mass spectrometer; (ii) a high-performance Orbitrap mass spectrometer; (iii) a versatile ion trapping device (omnitrap) for gas-phase ion activation, dissociation, manipulation and separation; (iv) an ion mobility drift cell for separating fragment ions (v) a high-performance data acquisition system (FTMS Booster TD) for the optimum acquisition of unreduced data from Orbitrap mass spectrometer; and (vi) data processing and data analysis software tailored for the needs of top-down analysis of antibodies.

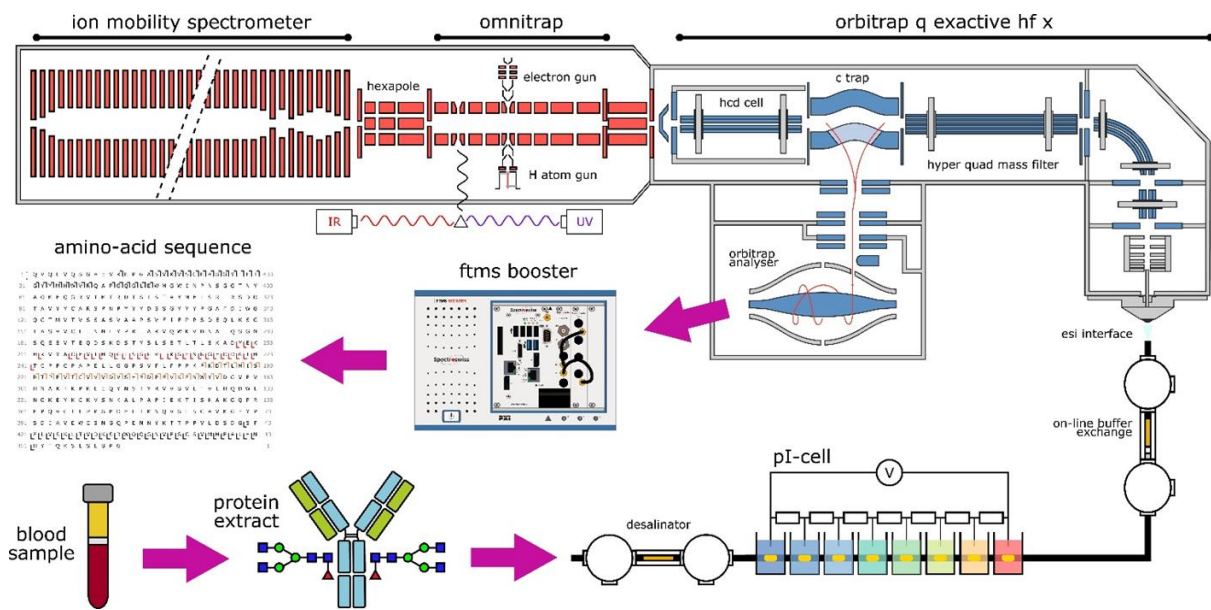

Figure 1. Overview of components of the proposed TopSpec platform.

A precursor design of the omnitrap sub-platform has been developed and top-down experiments with antibodies under native and denatured conditions are performed successfully. The precursor instrument has been pivotal for design and in order to address performance issues. While many details of the omnitrap instrumentation are finalized, continuing work on the precursor platform is currently concentrated on hyperthermal hydrogen atom bombardment, ion mobility separation of fragment ions and on software. The instrumentation development plan of the omnitrap sub-platform is shown in **Figure 2**. The original plan of producing two identical omnitraps for the Q Exactive HF instrument series has been revised. Instead two platforms, one compatible with the Q Exactive HF and a separate omnitrap sub-platform compatible with the new Exploris 480 instrument series have been designed. This latter sub-platform will exploit the enhanced sensitivity and mass resolution capabilities of this newest version of the orbitrap mass analyzer.

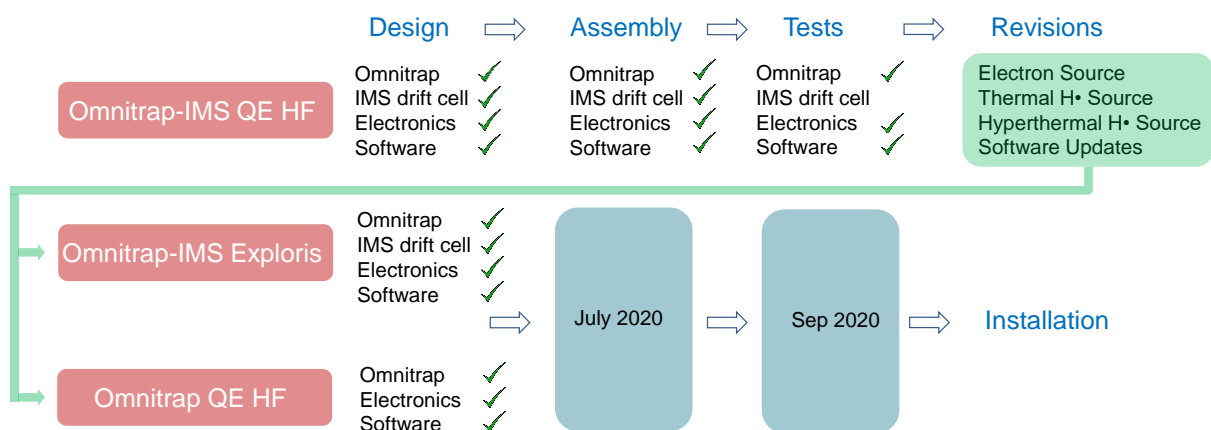

Figure 2. Instrumentation development plan highlighting progress milestones and the production roadmap for the TopSpec platforms.

The precursor omnitrap sub-platform installed at Fasmatech (Athens, Greece) and used extensively for hardware development work and finalization of the TopSpec platforms is presented in **Figure 3 (a)**.

In **Figure 3(b)** and **Figure 3(c)** spectra of trastuzumab produced under native and denatured conditions are shown. Top-down spectra of antibodies exploiting tools and methods available in the omnitrapp are presented with reference to WP2. Subsequent developments to be commenced on this platform include testing of the revised ion mobility device and preliminary tests of the hyperthermal hydrogen atom bombardment gun. Furthermore, the re-iterated electron source design for generating radical ions with high efficiency and investigating Coulomb explosion dissociation effects will be undertaken.

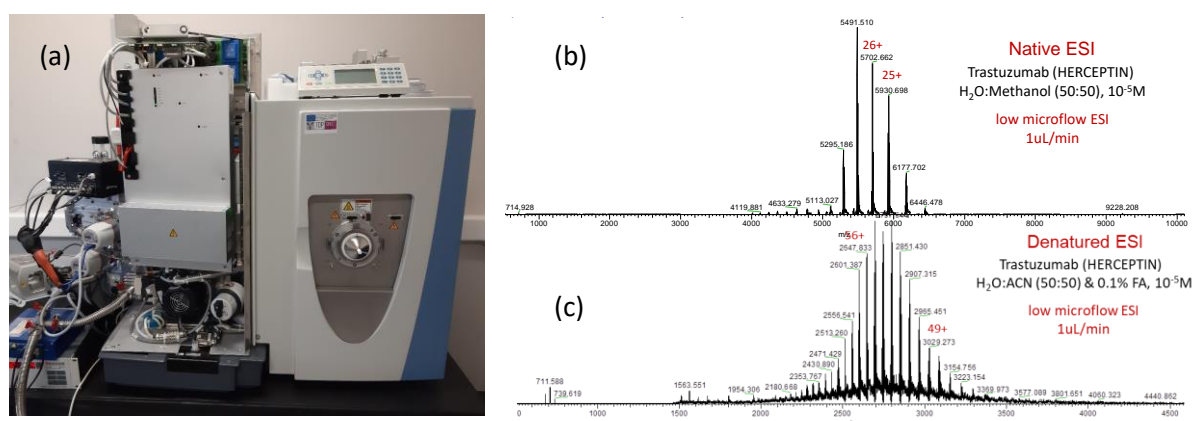

Figure 3. (a) Q Exactive HF installed in Athens and updated with the precursor omnitrapp platform. Mass analysis of intact trastuzumab performed under (b) native and (c) denatured conditions.

Progress is made in connecting the pI-Trap system with electrospray ionization. Separation of a simple protein mixture is demonstrated. A small-molecule based ampholyte has been selected, which provides improved signal-to-noise ratio for the detection of proteins. Efforts are made to balance the concentration of isoelectric focusing additives while maintain a stable spray. The design of the pI-Trap instrument has been finalized and the mechanical parts are currently being fabricated. Software is under development. No delays are expected, with the prototype of the automated pI-Trap being installed in August 2020. The development of the final configuration of the physical interface between pI-Trap Cell, buffer exchanger and electrospray ionization is on its way. Such interface should provide minimum band broadening and a footprint compatible with the ESI nanoflow source. Most recent implementation involve the integration of the nanospray needle, electrode and buffer exchanger in a single mechanical assembly. The connection of the pI-Cell with the ESI-needle/buffer exchanger assembly is being optimized.

The developments of the front-end (separation and ionization) and the ion processing part (Orbitrap and omnitrapp) of the TopSpec platform have been accompanied by the allied developments of data acquisition hardware and data processing/analysis software. The main objectives of data acquisition and processing/analysis development have been achieved and correspond to the current state of a complete TopSpec platform development. The hardware tools (data acquisition systems) are ready for their integration into two TopSpec platforms. The software tools (both data processing and data analysis) have been developed and tested using reference data sets acquired from diverse Orbitrap mass spectrometers equipped with advanced capabilities, including ultra-high resolution, native mass spectrometry, as well as HCD, ECD and UVPD MS/MS. The tools are ready for data processing and analysis of data acquired from complete TopSpec platforms. The overall timing matches the original schedule.

1.1 Objectives

The targeted breakthrough of TopSpec is its unique ability to sequence whole intact antibodies. This breakthrough is expected to substantially reduce the development costs of new drugs and dramatically reduce the time to market. **The specific TopSpec objectives are:**

1. **Sequence** - The biggest problem in top-down MS/MS: sequencing of large proteins, will be solved by implementing novel gas-phase radical reactions in the ground-breaking MS/MS device, the Omnitrap. An ion mobility (IM) device will be attached to it, providing hardware deconvolution of overlapping isotopic clusters that present a daunting problem for deconvolution algorithms. The ions will then be detected by an Orbitrap mass analyser with extended functionality, including ultra-high resolution capability.

The development of radical ion reactions in the gas phase is performed on a precursor omnitrapp sub-platform designed with enhanced functionality. Investigations on this first development sub-platform involve reactions of protein ions with electrons and hydrogen atoms. Electron meta-ionization with minimal fragmentation (electron induced dissociation) has been accomplished for proteins. Hydrogen attachment to heme-proteins has also been observed with an upgraded version of a thermal hydrogen atom source. These novel reactions are integrated in multiple-stage tandem mass spectrometry (MS3) workflows demonstrating the capabilities of the omnitrapp platform for in-depth top-down characterization of proteins. Results are presented for different charge states of ubiquitin ions providing enhanced sequence coverage information. Extending these methods to monoclonal antibodies (mAbs) analyzed under denatured and native conditions is underway. Preliminary top down experiments with intact mAbs performed on the omnitrapp sub-platform connected to an upgraded Q-Exactive HF are also reported.

Further hardware developments are concerned with the design, testing and application of the hyperthermal hydrogen atom bombardment (HAB) gun as well as experimental investigations of Coulomb Explosion Dissociation (CED) effects using high energy electrons. The status of this part of the work including recent experimental data is discussed. In addition, an alpha prototype of the ion mobility drift cell has been designed and tested. Ion mobility separation of precursor and fragment ions is demonstrated. A second version of the ion mobility device is currently being assembled to address problems encountered in terms of resolution and transmission characteristics of the prototype device.

Successful testing of the HAB, CED methods as well as the ion mobility device will finalize the design of the two consecutive omnitrapp sub-platforms to be delivered by Fasmatech to the Consortium. The first omnitrapp sub-platform to be equipped with the ion mobility drift cell will be connected to an Exploris 480 mass spectrometer (Karolinska Institutet) while the second stand-alone omnitrapp will be attached to a Q-Exactive HF (Pasteur Institute).

It is emphasized that in parallel to the capabilities of the analytical platform to separate fragment ions by ion mobility and to the enhancements in signal acquisition offered by the FTMS Booster TD, the superior MS3 performance capabilities demonstrated in the omnitrapp platform will allow to generate and isolate subunits of mAbs for producing spectra amenable to *de novo* sequencing algorithms due to their reduced complexity and high mass accuracy of the fragment ion detection afforded by Orbitrap FTMS equipped with FTMS Booster TD. **Figure 4** shows TopSpec tools under development to resolve spectra congestion and perform *de novo* sequencing of mAb mass spectra with high efficiency.

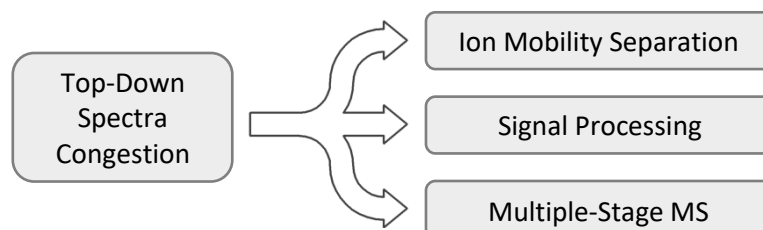

Figure 4. Tools available to resolve top down spectra congestion

2. **Analyze** - To solve the next-biggest problem in top-down MS/MS: implementing novel deconvolution procedure to attribute isotopic peaks to individual molecules or fragments. The custom-designed FTMS Booster TD will offer the most modern advances in signal acquisition and real-time data processing. Furthermore, it will increase the MS/MS spectra quality and radically simplify them via our breakthrough deconvolution algorithm.

Approaches and technologies to maximize the information output from the experimental data is under development by TopSpec partners with a lead by Spectroswiss and Nottingham Trent University. First, data acquisition strategies with real-time signal processing have been designed to accurately record motion of ions in orbitrap mass analyzer for the full period of their coherent motion (e.g., acquisition of transients with extended periods and with artifact-free phase functions). Second, methods to overcome space charge effects in orbitrap mass analyzer were introduced to further enhance ion signals when complex ion populations are analyzed and ion-ion interactions may reduce ion signal quality. Examples of these methods include narrow m/z window MS/MS spectra acquisition followed by data stitching technologies and data averaging from technical replicates, with the final experimental sequence that combines both of these approaches. Third, data processing of the accurately acquired (and integrated from narrow m/z windows and/or technical replicates) transients is performed following diverse strategies, not being limited to a full transient processing with Fourier transform which constitutes modern FTMS approach. For example, transient processing is performed in a data-dependent approach, which matches analysis of ions of interest (by mass and charge state) with the transient length. Another example includes evaluation of a TopSpec hypothesis that product ions can be deconvolved by their decay rates in extended duration transients acquired from Orbitrap FTMS. Indeed, product ions in top-down MS of mAbs differ significantly in their mass and charge states, creating an extremely congested product ion distribution. We realize that due to the differences in their decay rates, overlapping isotopic distributions of product ions can be decoupled and analyzed separately, thus increasing the total sequence coverage and confidence in product ion annotation.

In addition to the signal processing technology spearheaded by Spectroswiss and Nottingham Trent University, a new software platform is developed in parallel by Fasmatech to accelerate manual processing of complex top down spectra. This platform will be an essential step for post processing the vast amount of information produced in the omnitrapp by allowing faster interpretation of novel fragmentation pathways of proteins with known sequences. Score functions to fit experimental isotopic distributions have been developed and the software is currently used extensively to study HAB, CED and MS3 spectra of proteins. The *de novo* algorithm part of the software is currently under consideration and developments will follow upon debugging the existing version.

3. **Optimize** - To optimize the front-end, online separation of large proteins, by replacing the conventional (and poorly suitable for large proteins) high-pressure reversed-phase liquid chromatography (LC) with a revolutionary novel low-pressure separation device called the pI-Trap.

The pI-Trap platform will provide isoelectric focusing separation of antibodies to facilitate and enhance the detection of low abundance or isobaric proteoforms by decreasing sample complexity. Additionally, it will provide the isoelectric point value which could be later correlated with the resulting mAb sequences generated by the Omnitrap-Orbitrap Mass spectrometer. Currently, Biomotif AB is designing and building an automated system that will provide isoelectric focusing coupled with electrospray ionization mass spectrometry, as well as developing methods and interfaces for sensitive and robust ESI-MS analysis.

The development a dedicated pI-Cell for high-capacity and fast separations is at the final stages, as well as the selection of a suitable ampholyte and isoelectric focusing additives. At present, the optimum physical configuration of the nano electrospray and the pI-Trap cell is under consideration.

4. **Combine** - To combine in a seamless way the above components into a TopSpec instrumentation platform by designing sophisticated software to control the whole platform as a single apparatus. Novel software for data acquisition, processing and analysis, including de novo protein sequencing, will be created.

Extensive developments in signal processing and spectra interpretation algorithms have been undertaken by partners of the Consortium both jointly and also separately (Thermo Fisher, Spectroswiss, Nottingham Trent, Fasmatech).

Modifications to the Q Exactive control software have been completed (Tune) and the new functionality necessary to transfer ions between the HCD cell and the omnitrap sub-platform has been tested successfully. The development of a communication protocol between the Q Exactive and the omnitrap platform is under consideration to permit real time decision making. Discussions between Thermo Fisher and Fasmatech are underway. Automated algorithms to perform secular frequency calibration under variable space charge loads in the omnitrap sub-platform are under development. A fully functional software platform is created to drive the complex functionality in MS2 and MS3 modes. Most recent implementations involve integration of the HAB and CED functionality in the event sequence files used to define the ion processing method. Critical to enhancing spectra quality in MS3 mode are developments related to operating the omnitrap in ion accumulation mode and these have also been completed successfully. A remaining item is the simplification of the complex event sequence file structure to be replaced by a more user friendly interface for ion processing method development.

Information flow from orbitrap mass analyzer is first processed in real-time on FPGA chips of FTMS Booster TD data acquisition system, from where digitized information is saved to a data storage module following the most efficient data storage practices. Thus, the stored data is then processed by Spectroswiss routines to yield mass spectra (in .H5 file format) with the most information preserved. These files are then processed by Nottingham Trent data analysis software tools that have been adapted to accept structures of these .H5 files. The output of Nottingham Trent software tools are visual and ready for analysis graphs and sequence maps.

5. **Utilize** - This will then allow us to create novel top-down strategies that will fully utilize the analytical power of TopSpec to sequence large proteins, and to implement these strategies for solving disease-related and drug-development problems and limitations.

An MS3 strategy for the analysis of intact mAbs is under development with most critical aspects of the workflow already evaluated experimentally using smaller protein ions. In conjunction with the additional functionality offered by the ion mobility separation device, the problem of spectra congestion is expected to be resolved. As a result, the efficiency of data processing algorithms to provide accurate sequence information will be enhanced. A critical aspect of this approach is to generate top-down spectra with sufficient signal-to-noise ratio. Operating the omnitrapp platform in ion accumulation is likely to be a prerequisite for this type of analysis, however, this can only be exercised at the expense of speed.

Analytical workflows for analyzing intact mAbs and LC-MS methods for separating sub-units and producing sequence information are currently tested using conventional techniques to establish the limits and to prospectively compare the results to the results obtained by the TopSpec platform by PI and KI.

Middle-down and top-down proteomics workflows using nanoLC-MS/MS were tested by partners of the IP on an Orbitrap Fusion Lumos. Antibodies were reduced or partially digested to generate various subunits (25kDa and 50kDa subunits) which were then separated by reverse phase chromatography and analyzed by tandem mass spectrometry. Even if subunits were sufficiently resolved from one another in chromatography, glycoforms were still co-eluting highlighting therefore the need for orthogonal and more resolute separations. The major proteoforms of the subunits were detected with a mass accuracy of less than 10 ppm. Several activation techniques were used for MS/MS sequencing in order to reach sequence coverages of 66% and 28% for the light and heavy chains respectively. Raw data were processed with different dedicated software (BioPharmaFinder™, ProSight Lite) and an in-house developed R script searching for neutral losses of water and ammonia. Similar tests (using microLC-MS/MS on Fusion or Lumos instrumentation) performed on intact and enzymatically (IdeS and PNGase F) modified mAbs have been performed at KI.

The middle-down and top-down workflows on light and heavy chains are currently being optimized to establish reference fragmentation data on standard commercial antibodies and benchmark the future benefits of the Omnitrap platform. Extending these methods to intact monoclonal antibodies is also underway.

1.2 Explanation of the work carried out per WP

1.2.1 Work Package 1

Work package 1 is concerned with the mechanical design and construction of the omnitrapp platform hardware. Extensive developments have been undertaken throughout the first year of the TopSpec project, involving mechanical design work, assembly, advances in electronics and software. A precursor omnitrapp platform and an ion mobility spectrometer have been built, fully equipped with electronics and control software for running tests. These efforts are summarized below.

Task 1.1 Mechanical design & testing (FASM, M1-M4):

Action 1.1: Two separate mechanical designs with enhanced functionality have been produced and critical subassemblies are currently on order. The first instrument is designed to connect on the Exploris 480 mass spectrometer, while the second design is adapted to the Q Exactive platform. This two-way approach allows for the omnitrapp platform to exploit the benefits of the higher resolving power offered by the Exploris while maintaining compatibility with previous instrument versions available in the market. **Figure 1.1** shows 3D cross sections of the two finalized mechanical designs. Differences are located in the RF hexapole bridges connecting the omnitrapp to the Orbitrap mass spectrometers. A precursor omnitrapp is operational since November 2019 and has served as the basis for finalizing the two instrument designs presented here.

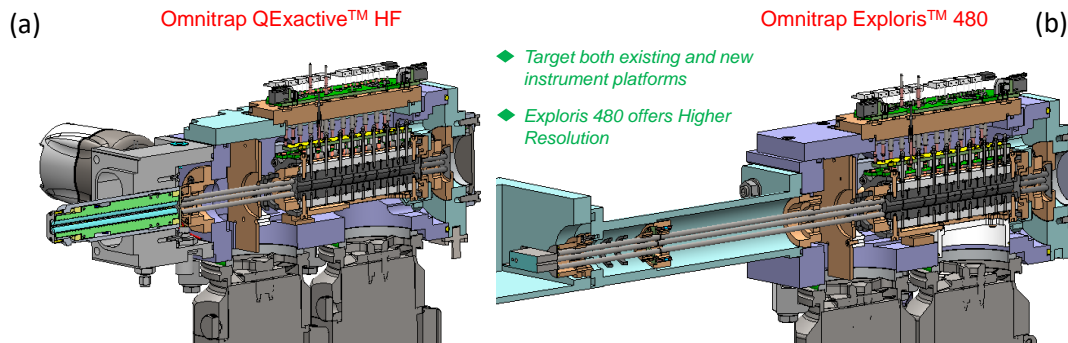

Figure 1.1. Mechanical models of omnitrapp connected to (a) the Q-Exactive and (b) the Exploris mass spectrometers.

Basic new features of the omnitrapp platform include enhanced pumping speed in the RF hexapole region, a baffle for screening H₂ gas from the orbitrap mass analyzer and a new multipin feedthru for distributing RF and DC signal to all electrode-poles in vacuum. Reduced capacitive coupling is achieved by truncating the hyperbolic electrodes of the omnitrapp without introducing higher order-field components that may have adverse effects on instrument performance. The multipin spring-contact feedthru distributing RF and DC signals on a two-level in-vacuum pcb for driving the omnitrapp is shown in **Figure 1.2 (a)**, together with a schematic diagram of the circuitry in **Figure 1.2 (b)**.

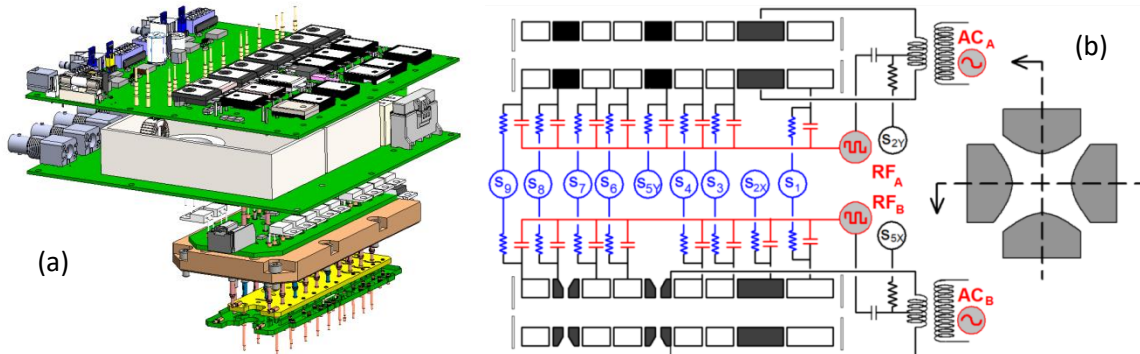

Figure 1.2. (a) New multipin feedthru for distribution of RF and DC signals and (b) circuitry diagram.

Figure 1.3 shows the finalized mechanical design of the omnitrapp platform equipped with an ion mobility drift cell. The ion mobility cell is inserted in a pressurized inner housing and installed between two high pressure transfer RF hexapole traps. Testing of the wire-free trapping gate, the multiple trapping regions distributed across the drift cell as well as the operation of the Badbury-Nielsen gate for band selection have all been performed experimentally. Revisions to electronics and in-vacuum pcb units are to resolve issues with resolving power and ion funnel mass discrimination effects have been finalized. The second version of the ion mobility device is currently being assembled.

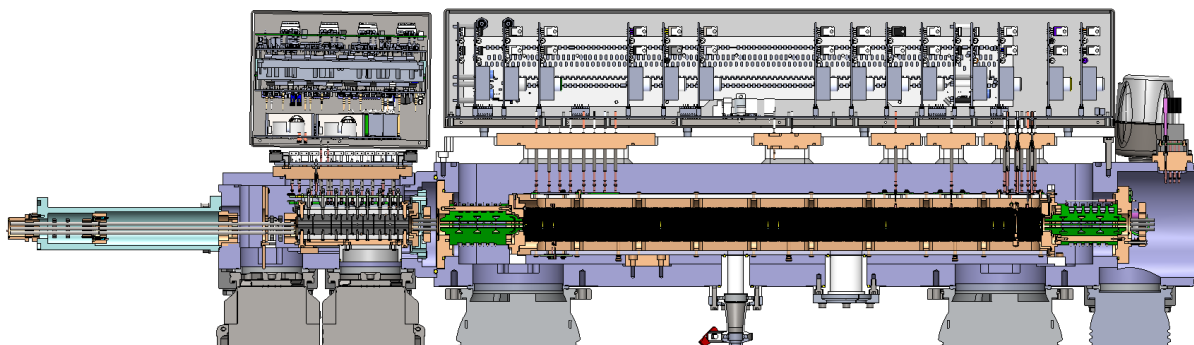

Figure 1.3. Finalized mechanical design of the ion mobility device attached to the omnitrapp Exploris 480 configuration.

The new pulsed electron beam source utilizes a new set of high voltage electron optics to enhance beam focusing under strong space charge conditions. A high voltage pulsing unit is integrated and synchronized with the main RF drive to deflect electrons and facilitate injection in segment Q5 at desired time windows. Additional steering-lens optics are integrated to maximize injection of electrons and accelerate ion-electron activation process. A 3D model of the side flange accommodating the variable energy electron gun and simulation results including space charge effects under electron capture and electron induced dissociation conditions are presented in **Figure 1.4**. Finally, modifications to the design of the electron source have taken into account the necessity of removing and replacing the filament on a regular basis as well as cleaning of the electron optical system.

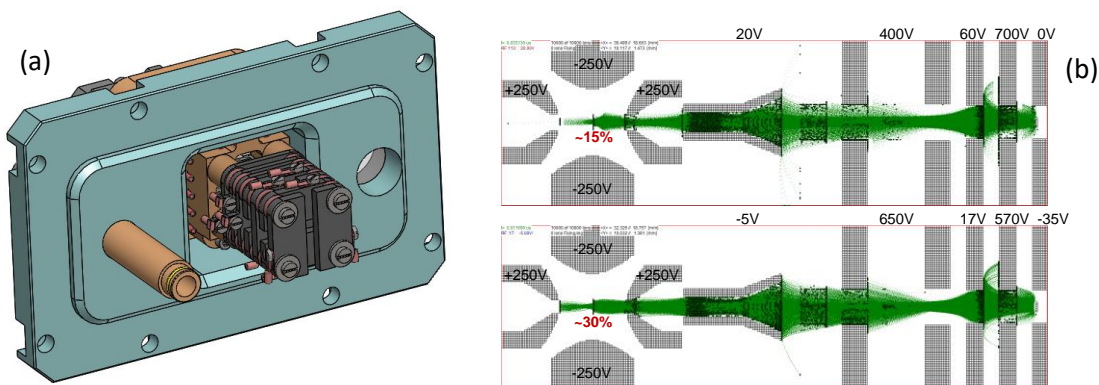

Figure 1.4. (a) High voltage electron source with steering optics and pulsed deflection and (b) simulation results under space charge conditions for electron capture and electron induced dissociation processes.

Task 1.2 Ion optical simulations (FASM, M1-M5):

Action 1.2: Ion isolation processes in the omnitrapp platform are investigated extensively by ion optical simulations and further explored by experiments. Investigations are performed across a wide range of m/z values and ions with different charge states. A comparison between the three different options available in the omnitrapp platform to select precursor ion masses and exploit the multiple-stage tandem mass spectrometry capabilities of the omnitrapp platform has identified optimum experimental conditions. **Figure 1.5 (a)** the application of a resolving DC to park ions at the tip of the stability diagram, which is currently the prevailing method for fast single notch precursor ion isolation, **Figure 1.5 (b)** rotation of the stability diagram by asymmetric duty cycle control of the rectangular RF waveform and **Figure 1.5 (c)** the application of frequency sweep waveforms with multinothc capabilities (advances in software for fast sweep calculation are underway). **Figure 1.5 (d)** shows the simulated and experimentally determined resolving power for the resolving DC isolation method.

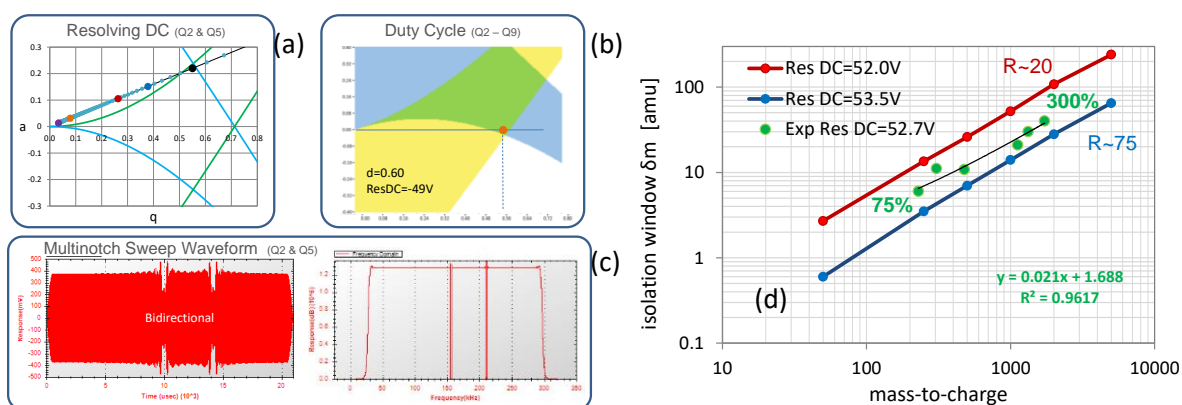

Figure 1.5. The three different precursor ion isolation methods available in the omnitrapp platform are (a) resolving DC, (b) asymmetric duty cycle control of the RF drive and (c) frequency sweep multi-notch waveforms applied in dipolar mode. (d) Experimental and simulated resolution of the ion isolation window.

Experimental evaluation of space charge effects on ion isolation and trapping efficiency has been performed. The stability conditions have been identified across the entire a - q space and non-linear resonances due to excessive space charge. Results indicate that the omnitrapp can accommodate at least 2M charges without experiencing performance issues that would compromise a top-down experiment. Finally, frequency calibration tables have been generated to automate mass selection,

however, revisions are required to accommodate secular frequency shifts at greater space charge loads.

Task 1.3 Electronics design & testing (FASM, M1-M7):

Action 1.3: An improved rectangular RF drive generator with voltage pulse stability of <3% and minimized jitter (1ns) was developed successfully. The target value of $250V_{op}$ at 2MHz has been achieved. Efforts to push electronics beyond this threshold are underway with the new target value set to $400V_{op}$. **Figure 1.6 (a)** shows the RF generator connected on the top flange of the omnitrapp platform. Water cooling is used to prevent overheating of the transistors and resistor at the highest RF frequencies applied. **Figure 1.6 (b)** shows oscilloscope traces at max RF amplitude and frequency available with the current setup.

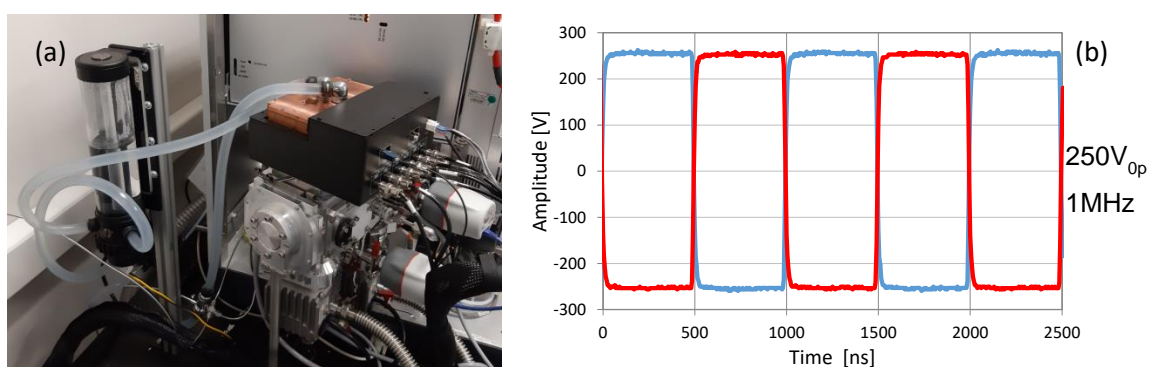

Figure 1.6. (a) RF generator mounted on the top flange of the omnitrapp platform and (b) oscilloscope traces of the two antiphase rectangular RF waveforms recorded at maximum amplitude and frequency settings.

Optimization of frequency sweep waveforms has been performed and multi-notch isolation experiments are now possible across a wide range of m/z values. This mode of operation will become useful in on-line experiments where multiple charge states of mAbs and subunits must be isolated for tandem mass spectrometry analysis, or in cases where higher resolution isolation compared to the resolving DC method is required. The FPGA platform is constantly under development and new features and functionality are introduced (VHDL language). New communication protocols are currently being developed that will allow for automated frequency calibration procedures and also the application of targeted analysis to allow coupling with on-line front-end separation methods. Synchronization between the omnitrapp platform and the Q Exactive has been successfully completed.

Task 1.4 Mechanical & vacuum assembly (FASM, M7-M18):

Action 1.4: Assembly of two omnitrapp units and one ion mobility device is underway, following a successful set of experiments performed on the precursor platform and subsequent revisions made to address shortcomings. **Figure 1.7 (a)** shows parts of the ion mobility device currently being assembled for running final tests on the precursor platform. **Figure 1.7 (b)** shows parts of the precursor omnitrapp platform prior to assembly. Parts for the two subsequent omnitrapp systems are currently on order and a few more items are yet to be finalized (hyperthermal HAB gun, CED gun and final design of the ion mobility device).

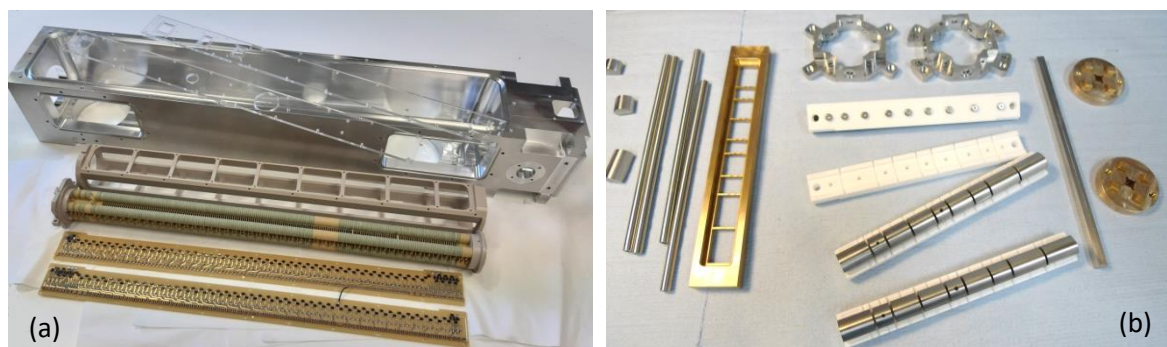

Figure 1.7. (a) ion mobility parts during assembly phase for final testing in the precursor omnitrapp platform and (b) precursor omnitrapp parts showing ceramic substrates, hyperbolic electrodes, mounting rings, spacers and alignment tool.

Modifications to the pumping system are introduced after observing the excessive hydrogen gas load and the adverse effects on the orbitrap mass analyzer during pulsed operation of the hydrogen atom source. An additional gas screen is installed to minimize leakage of hydrogen towards the orbitrap, forcing the gas to pass through a narrow slot on top of the turbopump. A residual gas analyzer has been used to monitor the purity of gases injected in the system. All gas lines comprise of stainless steel tubing and purging is available providing low water content and eliminating impurities and associated undesired effects. Improvements are required on the Q Exactive side where in-vacuum plasticizers have partial pressures sufficiently high to be ionized when electrons are injected in segment Q5. A major impurity ion at $m/z=248$ is observed in positive ion mode and at $m/z=246$ in negative ion mode. This impurity has not been observed when the omnitrapp platform is connected to orthogonal TOF mass spectrometers.

Task 1.5 Design control software (FASM, M6-18):

Action 1.5: The development of the omnitrapp control software is an ongoing process involving multiple updates on different aspects of the functionality throughout the course of the TopSpec project. The user interface is shown in **Figure 1.8**. A pool of instructions is available providing access to a wide range of commands allowing the user to build instruction sequence files for dynamic control of parameters including switching of axial DC profiles, gas pulses, pulsed injection of electrons, hydrogen atoms, ion isolation, combined activation methods etc. The integration of the ion mobility functionality has been completed. A wide range of MS2 and MS3 sequence files have been developed and standardized to a great extent. Future developments are associated with the design of bundle modes to simplify the user interface and automated procedures for secular frequency calibration across a wide range of m/z values.

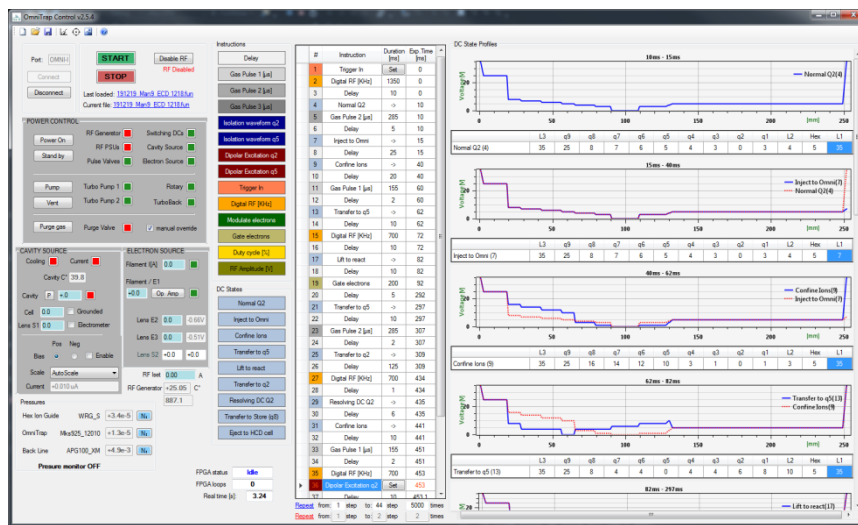

Figure 1.8. User interface showing instruction pool, sequence files and consecutive schematic diagrams highlighting the transitions of the DC profile during the course of an experiment to facilitate tracking of ions during processing.

Task 1.6 Electronics testing & synchronization (FASM, M10-M18):

Action 1.6: Communication between the Q-Exactive and the omnitrap platform has been established. A new sequence of DC levels and transitions of the DC gradients are produced for transferring ions between the HCD cell and the omnitrap. The DC transitions applied to the HCD cell and associated trigger signals to synch the two instruments are presented in **Figure 1.9**.

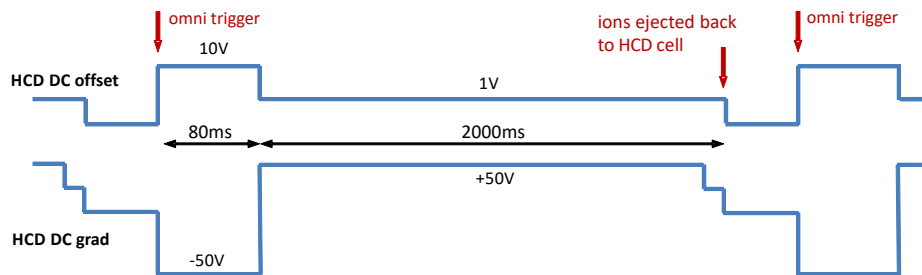

Figure 1.9. DC switching applied to the HCD cell and associated trigger signals for synchronization of the two instruments.

Task 1.7 Installation & instructions in situ (FASM, M14,23,28):

Action 1.7: Installation of the two instruments in Sweden (KI) and Paris (IP) was originally scheduled for July 2020, however, considerable delays in the development of the precursor omnitrap were experienced due to overheating of the Q Exactive turbopumps. This unexpected hardware complication was due to variations in the internal ventilation flow pattern. In addition, the design of a entirely new interface for coupling the omnitrap platform to the Exploris 480 mass spectrometer delayed developments further. It is estimated that installations are currently falling behind by at least a period of three months (October 2020).

Task 1.8 Modifications and optimization in situ (FASM, TF, M18-19, 26,30,33):

Action 1.8: Foreseeable modifications are likely to be avoided since most of the debugging work has been performed on the precursor omnitrapp connected to the Q Exactive HF in Athens. However, modifications considered necessary will be performed upon user request on site at KI and IP.

Task 1.9 Maintenance and servicing in situ (FASM, TF, M18,21,25,29,33):

Action 1.9: Experience during heavy duty operation of the omnitrapp platform has indicated a few aspects of the design that require attention. These are the pulse valve poppets which must be replaced on a two year basis due to wearing and also cleaning of the electron source and omnitrapp electrodes. No issues have been observed so far with electronics and in particular with the RF generator driven close to the specification limits for prolonged periods of time. Safety measures have been taken with multiple thermocouples monitoring critical electronics components and producing notification messages prompting the user to take precautionary measures.

1.2.2 Work package 2

Work package 2 concerns application and evaluation of existing ion activation methods for processing protein ions in the gas phase, as well as the development and optimization of new approaches involving electrons, hydrogen atoms, photons and combinations thereof. In addition to the extended ion activation network developed on and for the omnitrap platform, a series of top-down experiments on commercially available platforms is performed to benchmark performance. An extensive set of top down MS2 and MS3 experiments have been performed with protein ions on the omnitrap platform and preliminary data on antibodies have been produced and summarized below.

Task 2.1 Testing in situ ion isolation techniques (KI, FASM, IP, NTU, M15-17).

Action 2.1: Extensive experiments have been performed to optimize ion isolation in segment Q2 of the omnitrap platform. The resolution of the isolation window when a resolving DC is applied can be varied. For an average of ~10% loss in signal ion intensity, resolution varies according to **Figure 1.5** (page 12) where experimental results and ion optical simulations are compared across a wide m/z range. **Figure 2.1** shows a mass spectrum of the high mass calibrant used for tuning the Q Exactive platform. In this example, ions are transferred in segment Q2 of the omnitrap platform and an isolation window of ~40 is achieved for ions at $m/z \approx 7200$, raising resolution to $m/\delta m > 150$, which is more than sufficient to isolate charge states of antibodies in both native and denatured conditions.

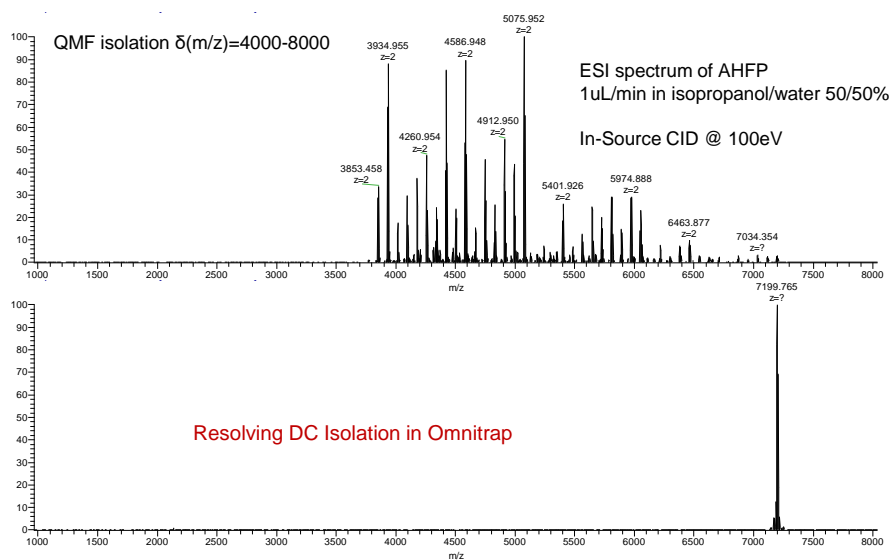

Figure 2.1. High mass calibrant and isolation window at $m/z = 7200$ with $m/\delta m > 150$.

The parameters of ion isolation have been optimized, particularly with respect to the presence of the buffer gas. Multi-notch isolation has also been accomplished and software development routines are currently being developed to automate the process.

Task 2.2 Testing in situ collision-activated, UV and IR dissociation reactions (KI, FASM, IP, NTU, M16-18)

Action 2.2: Enhanced slow heating Collisional Induced Dissociation (CID) of protein ions is accomplished in the omnitrapp platform. A significant advantage compared to other instrumentation platforms is the dynamic control of pressure using multiple pulse valves and the differential pumping. CID conditions can therefore be tailored to the dynamic pressure profile in order to optimize dissociation and trapping of high mass fragments. Another essential aspect of the efficient slow heating CID is the enhanced vibrational excitation rate and the reduced internal energy relaxation rate attributed to the fast transitions of the rectangular RF drive, as compared to sinusoidal RF driven ion traps. **Figure 2.2** shows the sequence coverage for ubiquitin 8+ ions, fragment ion abundances and

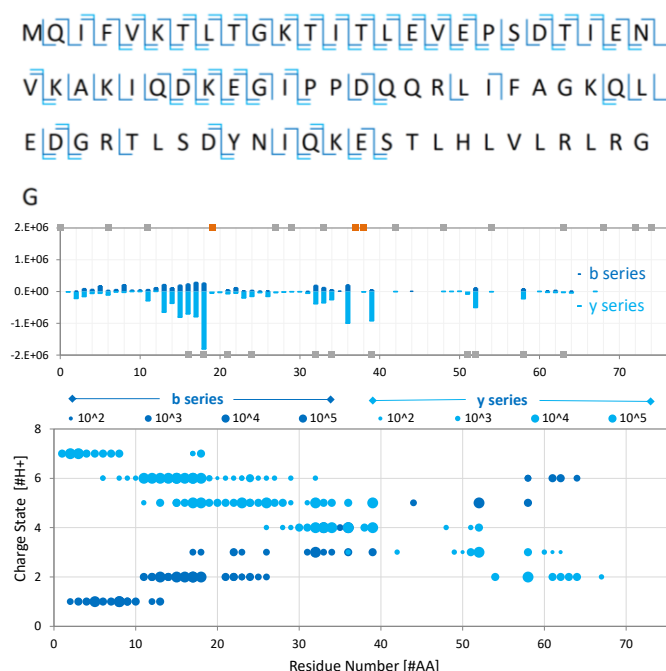

Figure 2.2. Sequence coverage of ubiquitin 8+, fragment ion abundances and fragment charge state distributions.

fragment charge state distributions, respectively. This data set has been processed manually and is in excellent agreement with information available in the literature. Additional low abundance fragments are observed and attributed to the omnitrapp performance and the exceptional dynamic range of the Orbitrap analyzer. Slow heating CID has been extended successfully to cytochrome c and to proteins with greater m/z, including antibodies. It is also noted that beam type CID, equivalent to HCD fragmentation has been accomplished for smaller protein ions in the omnitrapp platform. Future efforts will focus in extending the m/z range of beam type CID to antibodies and to make the method accessible in MS3 mode.

Ultraviolet photodissociation (UV PD) in the Omnitrapp platform has not yet been performed, however, a new deuterium lamp has been incorporated into the mechanical design and all parts have been ordered. New electronics are being developed to drive a shutter and provide UV photons in pulsed mode, compatible with the instruction sequence files developed for driving the omnitrapp. Additional UVPD experiments are performed by IP which is responsible for the benchmarking aspect of the project. See results presented below.

Infrared Multi-Photon Dissociation (IRMPD) in the omnitrapp is no longer considered a necessity. It is understood that IRMPD will offer no competitive advantages compared to collisional activation. It is also unlikely that IRMPD will play an important role in the MS3 strategies currently considered for dissociating antibodies sequentially in MS3 mode and sequencing regions of interest based on spectra with reduced complexity.

Task 2.3 Testing in situ ECD, HAB and CED MS/MS techniques (KI, FASM, IP, NTU, M15-19):

Action 2.3: Extensive experiments have been performed on the precursor omnitrapp using variable energy electrons. The ability to scan the energy range of externally injected electrons allows for ion-electron interactions to be investigated from the low energy range (<1 eV) where electron capture is efficiently accomplished, to the higher energy range (>10 eV) where electron meta-ionization and electron induced dissociation phenomena are observed. Complete sequence coverage is demonstrated for ubiquitin and cytochrome c in low electron energy Electron Capture Dissociation (ECD). Complete sequence coverage is also observed for ubiquitin in Electron Induced Dissociation (EID) experiments. **Figure 2.3** summarizes ECD and EID experiments performed in segment Q5 of the omnitrapp platform.

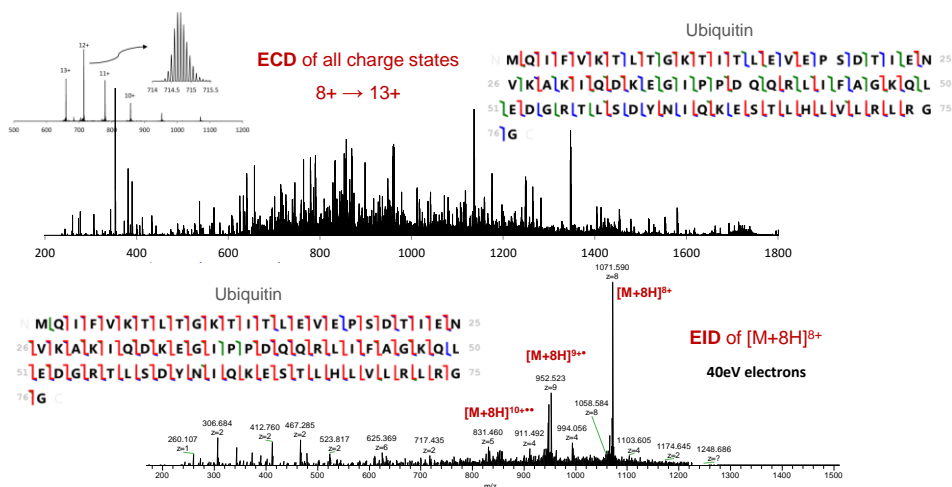
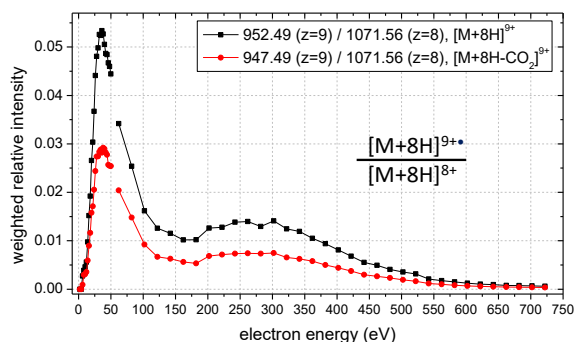

Figure 2.3. Complete sequence coverage of ubiquitin ions is obtained in ECD and EID experiments performed on the omnitrapp platform.

In addition to ECD and EID experiments, which are currently being applied to antibodies successfully, extensive experiments have been performed in the higher electron energy range (100eV – 1000eV) in search of the proposed Coulomb Explosion Dissociation (CED) mechanism. A detailed study of the electron ionization cross section of ubiquitin has been performed and processing of EID spectra produced with substantially different electron energies is currently underway. **Figure 2.4** shows the electron ionization cross section of ubiquitin extending from 0eV to 800eV. Two local maxima have been identified, however, these fall below the ionization threshold of inner cell electrons for C, N and O atoms (>400eV).



Single ionization of $[M+8H]^{8+}$

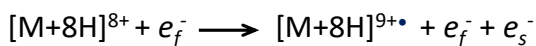

Figure 2.4. Electron ionization cross section of ubiquitin over an extended electron energy range.

Several designs of a molecular hydrogen atom cracking source have been developed and integrated into the omnitrapp platform. Mass-dependent hydrogen atom attachment reactions have been observed on z fragment ions produced by ECD while most recent experiments have shown extensive hydrogen atom attachment to heme B. Experiments are currently being performed to monitor intramolecular hydrogen atom rearrangements upon ion activation by CID and ECD.

Manufacturing of the first prototype hyperthermal hydrogen atom source has been completed. The design of this prototype unit was a result of extensive experimentation with two separate version of a pulsed free jet expansion plasma source. Characterization of the source and of the plasma product species was performed using a quadrupole mass filter, stopping potential experiments and ion-electron current measurements using electrometers. Testing of the hyperthermal HAB gun is

Task 2.4 Application of ECD, HAB and CED MS/MS techniques to analysis of proteins (KI, TF, M16-23)

Action 2.4: Using online LC ECD/HAB MS/MS in the omnitrapp to analyze mixtures of soluble proteins from *E. coli* is yet to be performed. These experiments will be undertaken on the two instruments to be delivered to Karolinska and Pasteur toward the end of 2020.

In parallel to the developments of the ion activation methods described above, a workflow for middle-down sequencing of antibody subunits was set up by partners of the Institut Pasteur (IP) in order to benchmark omnitrapp performance in the future. A reference monoclonal antibody, SigmaMab[®], was either reduced in denaturing conditions or digested with specific enzymes (IdeS, GingisKhan) and reduced in order to generate several different subunits with a variety of structures and molecular masses as shown in **Figure 2.5**.

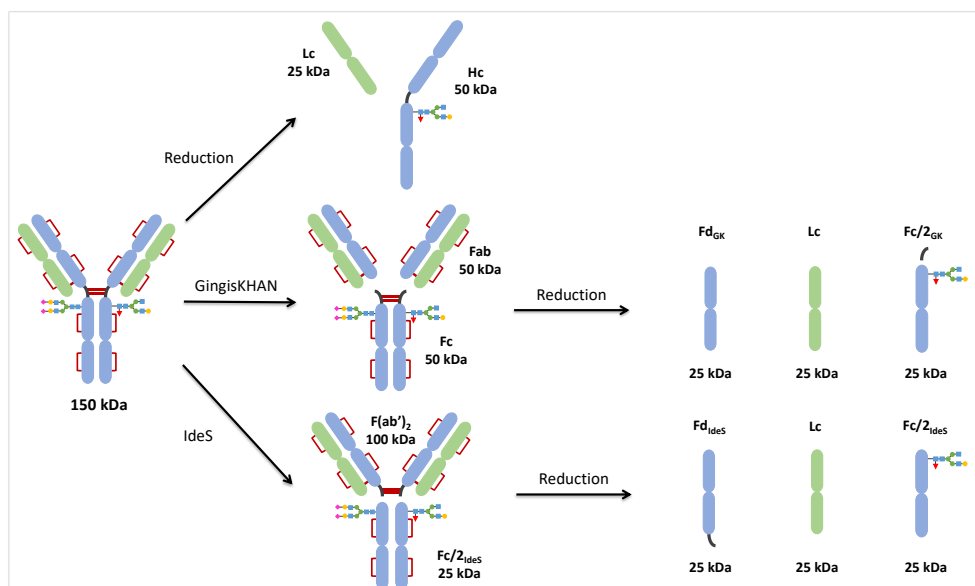

Figure 2.5. Subunits obtained after digestion or reduction of mAb.

These subunits were first analysed by nanoLC-MS using an Orbitrap Fusion Lumos to obtain mass spectra and to verify the molecular mass for each subunit after deconvolution with BioPharma Finder[™]. This intact mass analysis testified the effective digestion of the mAb with GingisKhan or IdeS and the complete reduction of inter- and intra-disulfide bridges. The major proteoforms for each subunit were detected:

- Lc and subunits containing Lc (Fab and F(ab')₂): the major proteoforms are modified at the N-terminus with the formation of pyroglutamic acid.
- Hc: 4 glycoforms (G0, G0F, G1F and G2F) are detected
- Fc/2: only the 2 major glycoforms (G0F and G1F) are detected
- Fc: several glycoforms combinations are observed (G0/G0F, G0F/G0F, G0F/G1F, G0F/G2F, G1F/G2F)

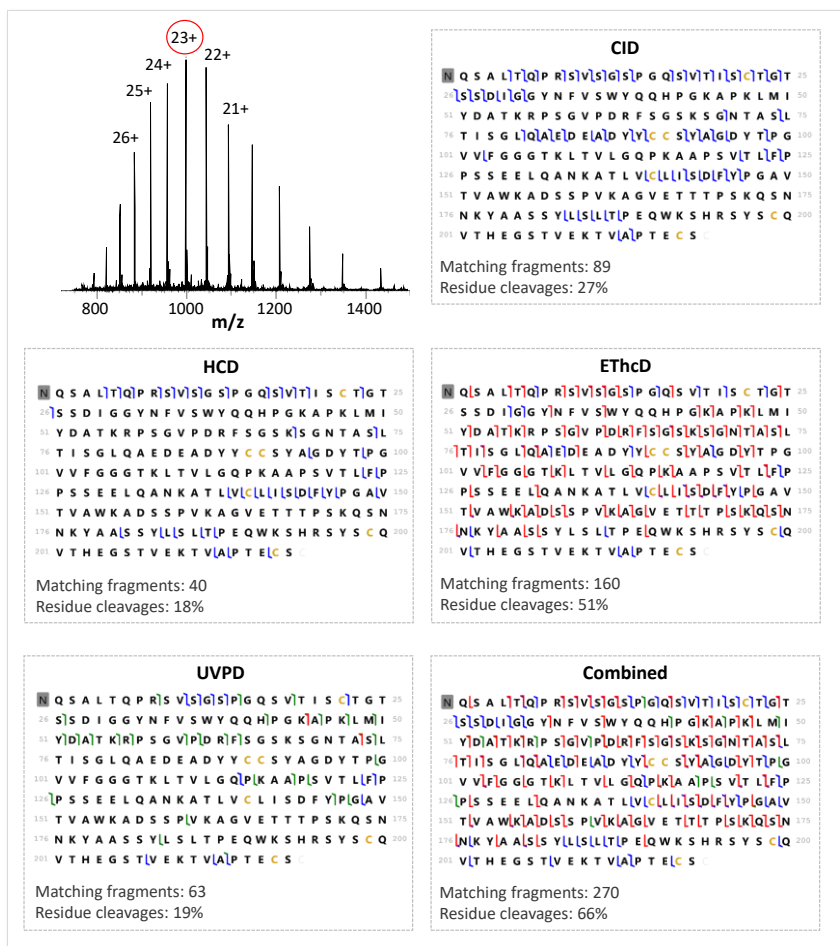

Figure 2.6. Mass spectrum of the major Lc proteoform (top left), fragmentation maps obtained with CID (NCE 25/30/35 %, top right), HCD (NCE 10/12/15 %, middle left), ETHcD (2ms + 5%/ 5ms + 5%/10 ms + 10%, middle right), UVPD (25/35/40 ms, bottom left) and the fragmentation map of the total fragments (bottom right)

Some subunits were then further analysed by nanoLC-MS/MS by applying various activation techniques (middle-down and top-down proteomics): collision-induced dissociation (CID), higher-energy C-trap dissociation (HCD), electron transfer dissociation supplemented with HCD (ETHcD) and ultraviolet photodissociation (UVPD). A single precursor charge state was selected for each subunit and submitted to multiple activation times/energies for each activation technique (total of 12 LC-MS/MS runs). A residue cleavage of 66% was achieved for the Lc, shown in **Figure 2.6**, whereas the residue cleavage for the glycoform G0F of the Hc shown in **Figure 2.7** reached 28%. A good sequencing of the N-terminus and C-terminus of the Hc was obtained by considering all

the fragments generated by the 4 activation techniques. Based on the results obtained with an Orbitrap Fusion Lumos, ETHcD performs the best but is not sufficient on its own to achieve very high sequence coverage. The experiments carried out at the IP highlight the necessity of combining several activation techniques for the sequencing of large proteins by MS/MS and emphasize the added value of the activation network that the omnitrapp will soon enable.

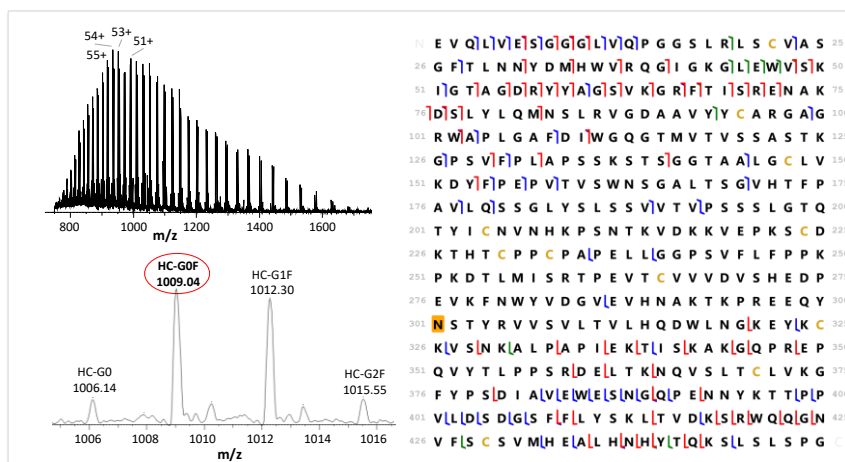

Figure 2.7. Mass spectrum of Hc (top left), zoom on 50+ charge state displaying the 4 major glycoforms of Hc (bottom left), fragmentation map of the total fragments (right)

The effect of the number of selected precursor charge states was also investigated by IP staff. All the previous fragmentation maps were obtained by targeting one single precursor charge state for each subunit. However, the distribution of charge states increases with the molecular mass of the protein in denaturing LC-MS and therefore leads to a repartition of the total intensity across a higher number of charge states. Three consecutive charge states (precursors 22+ to 24+ for Lc and precursors 49+ to 51+ for Hc) were co-selected and submitted to ion activation in order to assess the impact of co-selecting several consecutive precursor charge states (also called multiplexing) on the fragmentation. Three different activation techniques (HCD, EThcD and UVPD) with 2 levels of activation time/energy were used to generate a fragmentation of each subunit as representative as possible. Despite the fact that only 70% of all fragment ions for the Lc are shared between the 2 conditions, the residue cleavages obtained remain almost constant and the same behaviour is observed for the Hc.

Although the combination of 12 complementary LC-MS/MS acquisitions increases the sequence coverage obtained for both Lc and Hc by middle-down proteomics, this workflow is time-consuming. Based on the efficiency of each fragmentation technique and on the theoretical reaction mechanisms occurring in the gas-phase, IP staff decided to implement a LC-MS³ workflow, **Figure 2.8**, that would combine the strengths of 2 activation techniques: UVPD and EThcD. UVPD was chosen at the MS/MS level to generate big radical ions that will be easier fragmented by EThcD at the MS³ level. 42% of residue cleavage was obtained in a single LC-MS³ run.

Intact NIST antibody and Herceptin® (Trastuzumab) were also analysed by native mass spectrometry on a Synapt HDMS G2SI instrument in infusion (Nanomate) after desalting using a Biospin column. Four major glycoforms were identified, **Figure 2.9** after deconvolution with MaxEnt™ (Waters). Analysis of intact antibodies, either in native or denaturing conditions, will be soon transferred on the Q-Exactive HF mass spectrometer equipped with BioPharma option and modified with the Omnitrap.

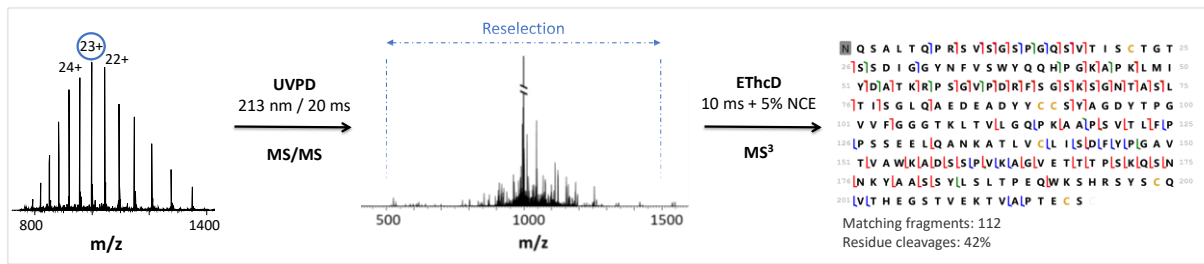

Figure 2.8. LC-MS³ workflow applied on the 23+ charge state of the major Lc proteoform

The main contribution of the IP to WP2 up until now is the development of middle-down and top-down proteomics workflows on a standard monoclonal antibody by nanoLC-MS/MS. These workflows will be optimized in the next months in order to define fragmentation references, in particular for intact antibodies (150 kDa) to be compared to the results that will be obtained with the Omnitrap. The experiments will also be performed on the Q-Exactive HF mass spectrometer that will be modified with the Omnitrap. However, the interest of using the Lumos platform available in the lab of IP partner is to enable the comparison of several activation techniques, since only HCD is available on Q-Exactive instruments.

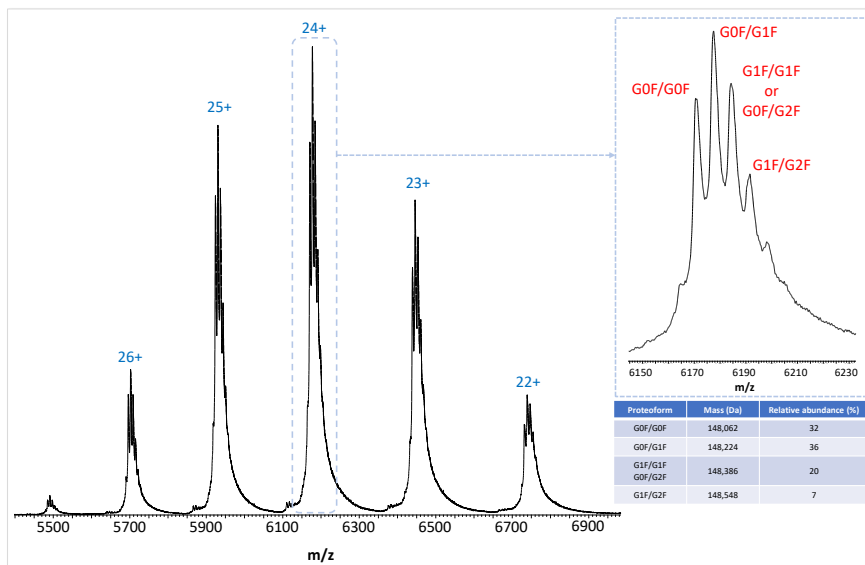

Figure 2.9: Intact mass spectrum of trastuzumab (Herceptin) in native conditions on a Synapt HDMS G2SI (left), zoom on the 24+ charge state annotated with the 4 major glycoforms (top right) and table of the identified glycoforms (bottom right)

Similarly to the preparations made by Pasteur Institute, Karolinska Institutet has performed initial tests on the reference monoclonal antibody, (NIST mAb, reference material, RM 8671), using established middle down and top down analysis on in house instrumentation (Fusion or Lumos orbitrap instruments interfaced with a Ultimate 3000 nano system operating in the microflow mode, using an Acclaim Pepmap 300Å C4 reversed phase column). To investigate the quality of the generated data, the instrumental method was set up for high throughput analysis, i.e. a fixed set of runs using standard methods (as provided in the literature).

As shown in **Figure 2.10**, the signal to noise ratios in mass spectra obtained for the intact mAb generated using Lumos orbitrap instrumentation (operating in intact protein mode with an ion routing multipole pressure of 1-2 torr acquired at 240 K with a max injection time at 100 ms) were poor. From the deconvoluted spectra of deglycosylated (22B) and intact (22D) mAb it is evident that the mass shift compared to theoretical value is corresponding to glycosylation (i.e. two N-linked glycan chains, FG0/FG0, FG0/FG1 etc), but the mass accuracy needs to be improved. Due to the low signal abundance in full scan mode no attempts were made to generate MS_n experiments.

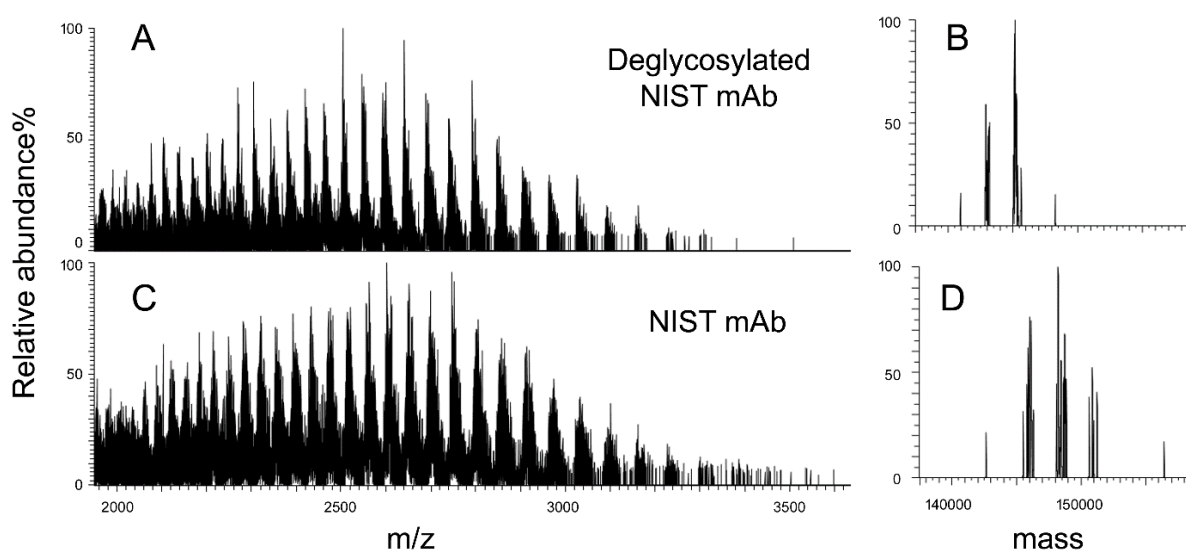

Figure 2.10. (a). Deglycosylated NIST mAb analysed on a Fusion Orbitrap instrument acquired at 240 K via on-line LC-MS experiment. (b) Deconvoluted spectra from A. (c) The corresponding analysis of the NIST mAb prior PNGase F treatment. (d) Deconvoluted spectra from C. Deconvoluted spectra were obtained via Thermo Biopharma Finder 3.2. using sliding windows algorithm (merge tolerance 30 ppm).

As expected, compared to the experiments on intact mAb, the results obtained using middle down analysis (on reduced and IdeS treated mAb), were of better quality. The data (shown in **Figure 2.11**) were generated using a Fusion orbitrap connected to the same LC system as described above. Top down analysis of the antibody chains (i.e. LC, FC and HC) were performed using targeted precursor isolation with set at 3 m/z and 5 ms injection times using EThcD and HCD simultaneous fragmentation.

Our results confirmed that analysis of intact antibodies, even highly purified standards, using even high-end modern commercial FTMS equipment is challenging. We expect that the TopSpec platform will improve the intact mAb analysis with improved proteoform resolution and precursor ion selection. TopSpec should also provide us with multiple high quality MS/MS fragmentation variants, which will result in high sequence coverage. Prospectively, TopSpec platform should provide quality data for oligo- and ideally polyclonal- Abs. For middle down analysis it should provide us with complete sequence coverage including full PTM coverage. Thus, an approach ideal for QC mAb high through put analysis.

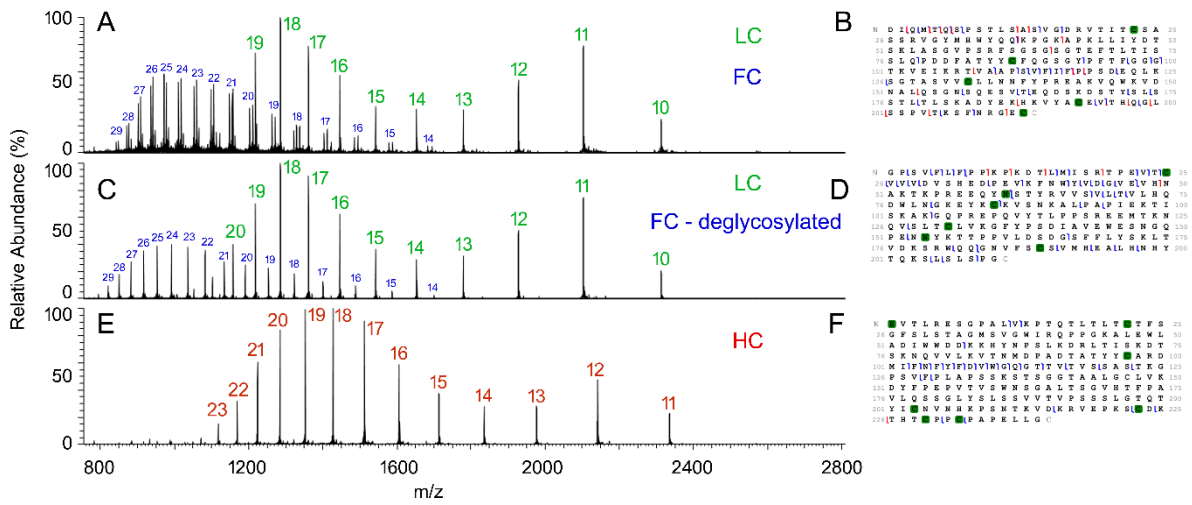

Figure 2.11. Middle down analysis of NIST mAb. **(a)** Spectrum showing the characteristic charge state pattern of the glycosylated FC and LC chains. **(b)** Sequence coverage obtained of the LC chain. **(c)** Similar spectrum as in A but on PNGase F treated material. **(d)** Sequence coverage obtained of the FC chain. **(e)** Spectrum showing the characteristic charge state pattern of the HC chain. **(f)** Sequence coverage obtained of the HC chain. Top Down analysis was performed using Thermo Biopharma Finder v 3.2.

1.2.3 Work package 3

Work package 3 involves development of a hyperthermal hydrogen atom gun for the investigation of hydrogen atom bombardment (HAB) reactions in the higher energy regime. Experiments so far with a thermal hydrogen atoms and smaller ions have produced exciting results (hydrogen attachment to radical fragments, heme B and heme proteins), however, the potential to enhance sequence information in top down experiments is yet to be established.

Task 3.1 Designing the hyperthermal H-atom gun (FASM, KI, IP, NTU, TF, M1- M7).

Action 3.1: The design of the pulsed plasma source has been finalized following extensive experimentation on a separate vacuum chamber and taking into account the strict vacuum system requirements imposed by the orbitrap mass analyzer. Experiments in continuous mode of operation have been conducted and conditions for maximizing the production of H^+ ions compared to H_2^+ and H_3^+ have been identified. In pulsed operation it has not been possible to characterize the plasma species injected into vacuum due to their short residence time and the slow scan rate of the residual gas analyzer employed for these measurements. **Figure 3.1 (a)** shows the ignited plasma during pulse gas injection through a flow tube. In this example plasma current injected in the form of a free jet expansion is monitored by a fast oscilloscope. The trace is shown in **Figure 3.1 (b)**.

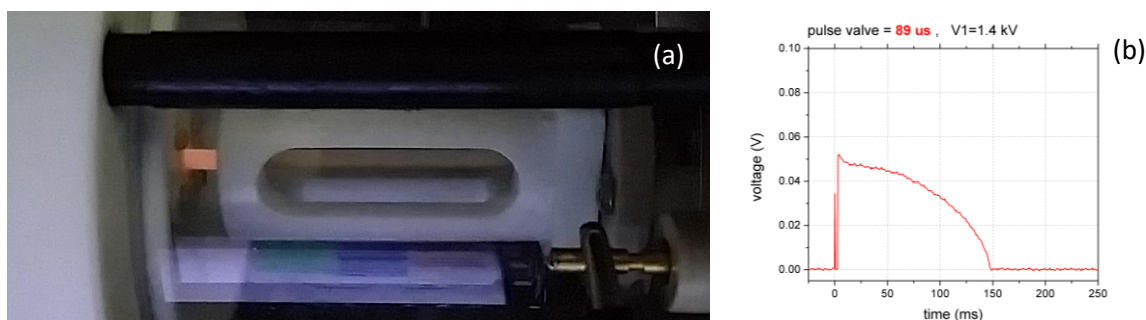

Figure 3.1. Free jet expansion flow of a hydrogen plasma injected into vacuum and the ion current collected onto an electrode and monitored by a fast oscilloscope.

Based on extensive experiments conducted on a separate vacuum chamber to understand free jet plasma flows and the associated kinetic energy of the plasma product species, and also following several iterations to the mechanical design to support new experiments, the design of the hyperthermal gun was finalized and presented in **Figure 3.2 (a)** and **Figure 3.2 (b)**.

The design of this new pulse plasma source utilizes DC potentials and fast pulse valves to raise pressure above the breakdown limit inside a flow tube. Ion pulse transients of the order of a few tens of ms are generated and injected into a secondary flow tube where negative charges are separated from positive charges. Positive ions are partially thermalized via interactions with the gas flow. A set of lens electrodes and deflector are subsequently employed to inject positively charged hydrogen ions into the neutralization tube. The neutralization surface is in a coaxial arrangement with the free jet axis of the pulsed plasma beam and the aperture on segment Q5.

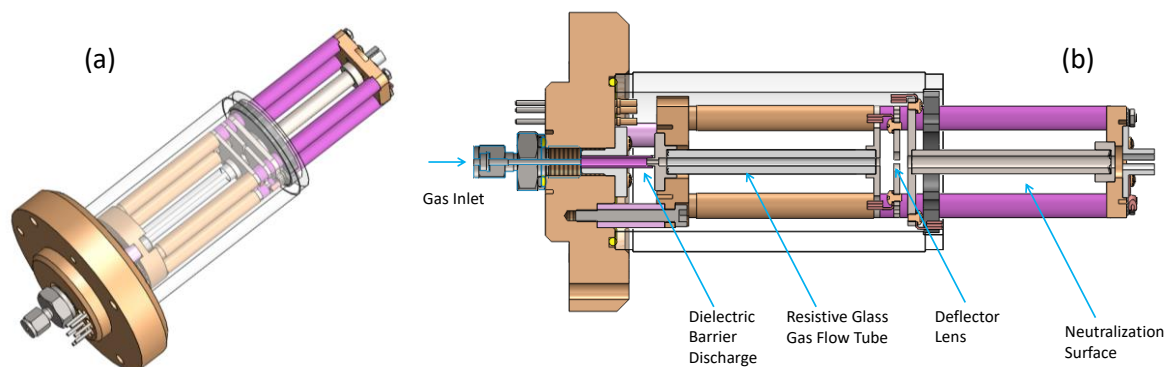

Figure 3.2. (a) 3D model of the hyperthermal hydrogen atom bombardment (HAB) gun and (b) a cross section highlighting the different regions of the system where plasma ionization, charge polarity separation and surface neutralization process are taking place.

Task 3.2 Building the hyper-thermal H-atom gun (FASM, KI, NTU, IP, TF, M6- M11)

Action 3.1: A prototype version of the hyperthermal plasma gun has been constructed. **Figure 3.3** shows the assembled device and the electronics board on the test bench in the final stages of debugging. Preliminary tests to investigate reactions between hydrogen atoms and protein species are underway.

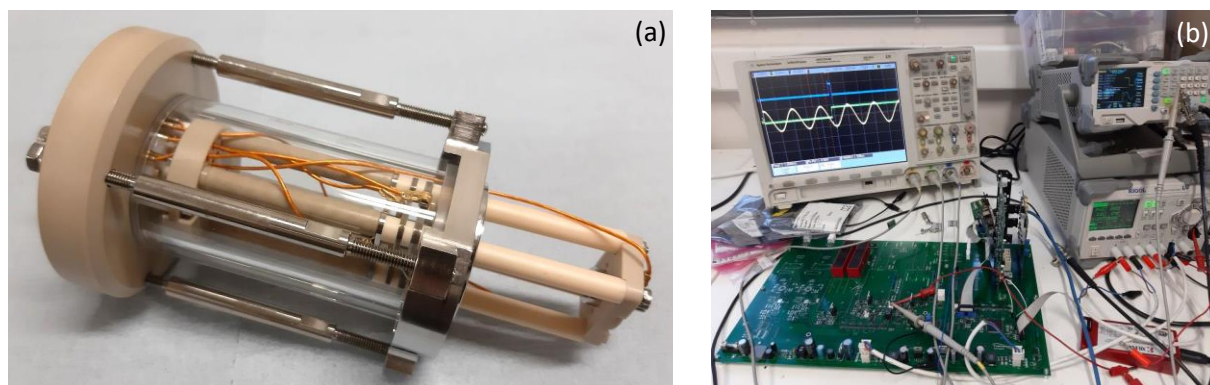

Figure 3.3. (a) Constructed hyperthermal hydrogen atom bombardment gun and (b) electronics unit in the final stages of debugging.

Task 3.3 Interfacing the H-atom gun system with Omnitrap (FASM, KI, NTU, IP, TF, M11- 12)

Action 3.3: The HAB gun has been interfaced successfully with the omnitrapp platform. Modifications to the side flange have been made and the new device is successfully integrated with the rest of the ion activation tools available in the system. **Figure 3.4 (a)** shows a 3D CAD model of the omnitrapp platform equipped with the hyperthermal HAB gun, while **Figure 3.4 (b)** is a horizontal cross section highlighting internal features of the mechanical design and particularly the coupling of the HAB gun with segment Q5.

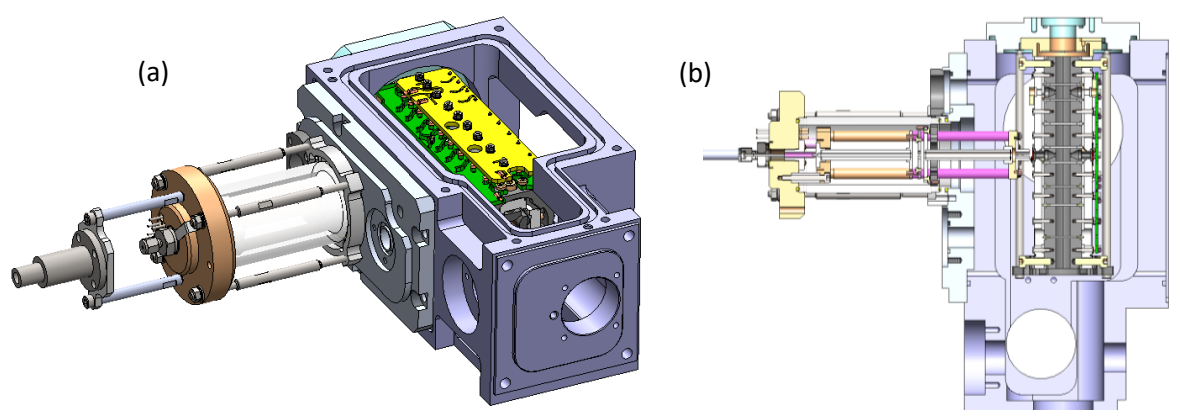

Figure 3.4. (a) 3D model of the omnitrapp platform equipped with the hyperthermal HAB gun and (b) horizontal cross section highlighting internal mechanical features.

Task 3.4 Develop of software for HAB MS/MS-Omnitrapp combination (FASM, KI, NTU, IP, TF, M8-13)

Action 3.4: Additional instructions to operate the HAB gun, namely a trigger signal for driving the pulse valve in a synchronized manner with a typical instruction sequence, DC potentials and deflecting voltage pulses are currently being implemented in the omnitrapp control software. Optimum settings for operating the gun will be converted into a bundle to simplify the sequence files and establish the control software more user friendly.

Task 3.5 Testing the HAB MS/MS- Omnitrapp combination (FASM, KI, NTU, IP, TF, M11- 13)

Action 3.4: Testing of earlier versions of the hyperthermal HAB gun on a stand-alone vacuum chamber has been performed. The next step is now to investigate reactions of plasma product ions and neutrals with multiply protonated ions in segment Q5 of the omnitrapp platform.

Task 3.6 Optimizing the software and hardware for HAB MS/MS. (FASM, KI, TF M18- M22)

Action 3.6: Feedback from the users in KI and IP will be essential for improving the technology. This feedback will be provided after exhaustive experiments on the two prototype units for a given set of proteins and understanding of the gas phase mechanism responsible for attachment reactions and fragmentation patterns.

Task 3.7 HAB MS/MS analysis of mAbs. (FASM, KI, M18- M24)

Action 3.7: The reactions of H atoms produced from plasma jets will be tested on mAbs and the effects will be investigated using advanced sequence algorithms for deciphering fragmentation patterns and measuring sequence coverage. H attachment reactions will also be evaluated and used for deciphering between even and odd electron species. The complementarity of this technique to ECD, CID or other standard fragmentation techniques will be evaluated.

1.2.4 Work package 4

Task 4.1 Designing the 100-1000 eV pulsed electron source (FASM, KI, NTU, IP, BM; M18 – M20).

Action 4.1: The design of the pulsed electron source in the energy range of 0-1000eV has been designed, tested and a second version with enhanced features is currently in the final stages of development. The electron source is a directly heated tantalum filament with low energy spread (<1eV) providing several microamps of electron current. **Figure 4.1 (a)** shows the latest version of the electron source and (b) a schematic diagram with lens-electrons and steering lenses to direct electrons in segment Q5. For more information about the design of the electron source see WP1 and particular **Figure 1.4** (page 12).

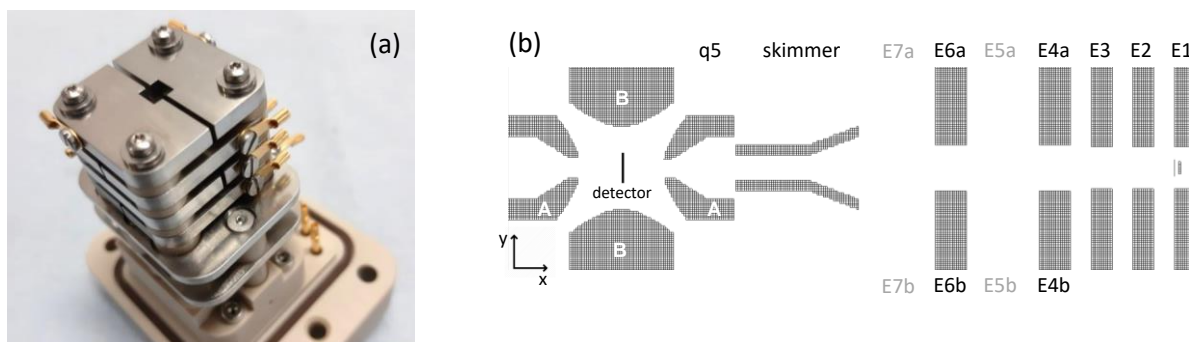

Figure 4.1. (a) New electron source with steering lenses and (b) schematic diagram showing optical elements for injection of electrons in segment Q5.

Experiments have shown that despite the high electron emission current produced by the 1.6mm diameter tantalum disk, the number of electrons injected in segment Q5 is limited by space charge to <350nA, particularly in low electron energy range. The density of the electron beam injected through segment Q5 can be increased to >500nA by raising the kinetic energy of the electrons to 1KeV. The tantalum disk has shown robustness against of the excessive gas injected into the omnitrapp through the pulse valves, which is necessary for transferring and cooling ions in different regions of the omnitrapp. Different cathodes were tested with less success (cathode dispensers and BaO filaments). The original specs for maintaining the potential of the emitter to $\pm 0.25V$ and further include a floating deflector voltage to allow injection of electrons in the omnitrapp at desired time windows has been met. Issues with the high temperature of filament have been carefully addressed. An electrometer has also been designed and incorporated into the electronics of the electron source to monitor electron emission characteristics of the tantalum disks.

Task 4.2 Building the 100-1000 eV pulsed electron source. (FASM, KI, NTU, IP, BM; M20 – M22)

Action 4.2: The electron source has been built and electronics are now completed. **Figure 4.1** above shows the constructed electron source, while **Figure 4.2 (a)** below shows the electronics board in the final stages of debugging. Testing of the new electron gun is on the agenda.

Task 4.3 Interfacing the 100-1000 eV pulsed electron source with Orbitrap MS (FASM, KI, NTU, IP, BM; M22 -23)

Action 4.3: The new electron source has been integrated with the omnitrapp platform. Modifications to the side flange are introduced and a 3D CAD model of the new assembly is presented in **Figure 4.2**

(b) respectively. All necessary triggers for driving the electron source are available from the original design.

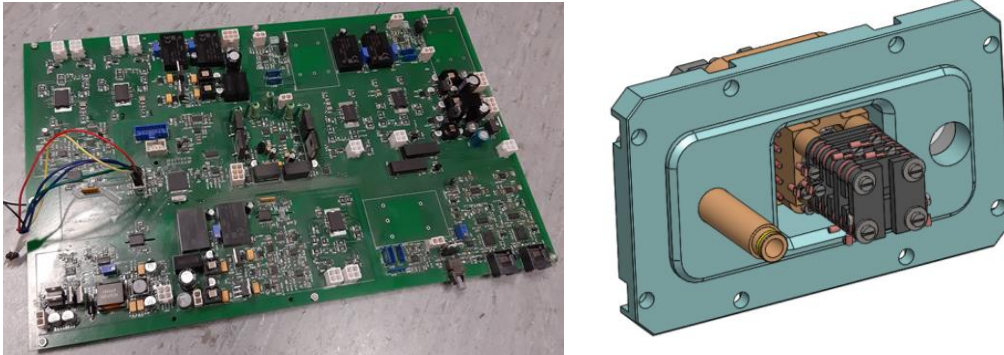

Figure 4.2. (a) Electronics board for driving the new electron source and (b) integrated electron source onto the omnitrapp side flange.

Task 4.4 Testing the Coulomb explosion MS/MS. (Lead: KI, Part: FASM, NTU, BM, IP; M23 – M24)

Action 4.4: Testing of the CED mechanism has been discussed in WP2 above, and specifically with reference to **Figure 2.4** (page 19).

Task 4.5 Optimizing the hardware and software for Coulomb explosion MS/MS. (FASM, KI, NTU, IP; M23-25)

Action 4.5: These steps will be undertaken after installing the instrument on site at KI and IP.

Task 4.6 Application of Coulomb explosion dissociation (CED) MS/MS to mAbs. (KI, FASM, NTU, IP; M23-28)

Action 4.6: These steps will be undertaken after installing the instrument on site at KI and IP.

1.2.5 Work package 5

Task 5.1 Designing and testing the pI-cell optimized for large proteins. (BM, KI, MS, TF; M15- M18) The peak capillary tubing and the tubular nafion membranes must be optimized in terms of length and diameter for best performance in analyzing large proteins. Tests with different ampholytes for getting optimum performance for protein analysis will be performed. Advice and expertise will be collected from partners KI, MS and TF.

Action 5.1: A high capacity pI-cell was constructed using capillaries with different inner diameters. Considering the numerous charge-state and isotopic distribution of proteins, the pI-cell was built to provide the maximum loading capacity (17 μ L of sample).

Two types of ampholytes were tested: a peptide-like based ampholyte, Pharmalyte (General electric), and a small-molecule based ampholyte, Aeslytes (CE Infinite, Advanced Electrophoresis Solutions Ltd.). Aeslytes provided better signal-to-noise and improved separation per a given percentage of the ampholyte.

For these studies, a solution containing myoglobin (pI 7.2) and/or Cytochrome C (pI 9.6) was used. The results are discussed on Task 5.2.

During the design of different pI-Trap Cells, a novel dual tandem pI-Trap cell configuration was conceived. The new configuration consists in two tandem pI-Trap areas, with the first area providing a fast and low-resolution separation and the second area providing a high-resolution separation. The new tandem configuration reduces the focusing time and provides improved separation. Based on these findings, a patent application is being prepared (**Figure 5.1**).

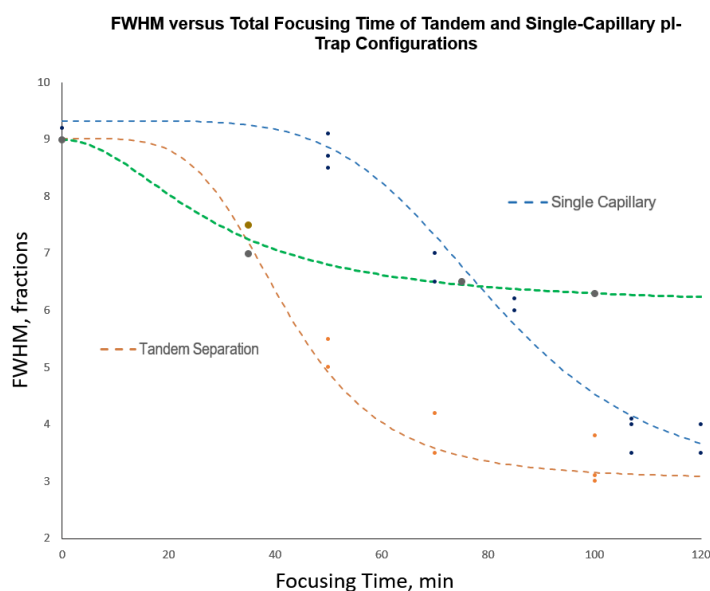

Figure 5.1. Performance of the Tandem pI-Trap Cells compared to a single-short or single-long pI-Trap Cell.

Task 5.2: Design and testing of the buffer exchanger ESI interface for pI-Trap. (BM, MS, TF; M16- M18). The configuration of the buffer exchanger (geometry of the semipermeable membrane as well as channel volume) must be optimized for improved performance when analyzing large proteins. Optimum washing flow rates and the chemical composition of the washing solution will be investigated as well as optimum time interval for the buffer exchange process. Work will be done with valuable input from MS and TF.

Action 5.2: Isoelectric focusing separations presents two main challenges for online connection to ESI MS. First, the inherent necessity of generating a pH gradient is detrimental for ESI MS of polypeptides, which requires a stable acidic environment. Second, the necessity of using ampholytes and other molecules to improve the solubility of polypeptides during focusing (e.g. urea and glycerol) produces a dramatic decrease in ESI MS sensitivity and stability. To solve these issues, a microfluidic membrane-based device was constructed and connected between the ESI needle and the outlet of the pI-Trap cell. Using this setup, a stable and acidic pH was obtained (**Figure 5.2**).

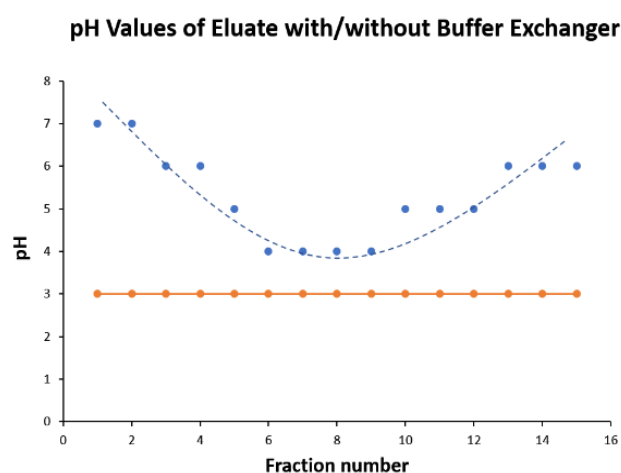

Figure 5.2. Task 5.2. pH versus fractions eluted from the pI-trap cell without (blue) and with (orange) the buffer exchanger.

A series of experiments were performed to find the proper balance between the concentration of isoelectric focusing additives and electrospray stability. Standard pI-Trap separation utilized 2M urea, 30 % glycerol and between 2 to 10 % of ampholyte. Initial difficulties with protein precipitation without the use of urea were overcome using between 20 to 30 % glycerol. Thus, currently, no urea is added in the pI-Trap based isoelectric focusing separation.

The combination of the buffer exchanger device and the methods developed thereof with the optimized tandem pI-Trap device allowed the successful MS analysis of pI-Trap fractions from a mixture of proteins (**Figure 5.3**).

Task 5.3 Design controlling software for pI-Trap-Orbitrap combination (BM, TF, MS, NTU; M18- 20)

Action 5.3: This will be done in close collaboration with TF, MS and NTU. We will also need support and input from Spark Holland and DataApex for best adaptation with the software controlling autosampler and fraction collector.

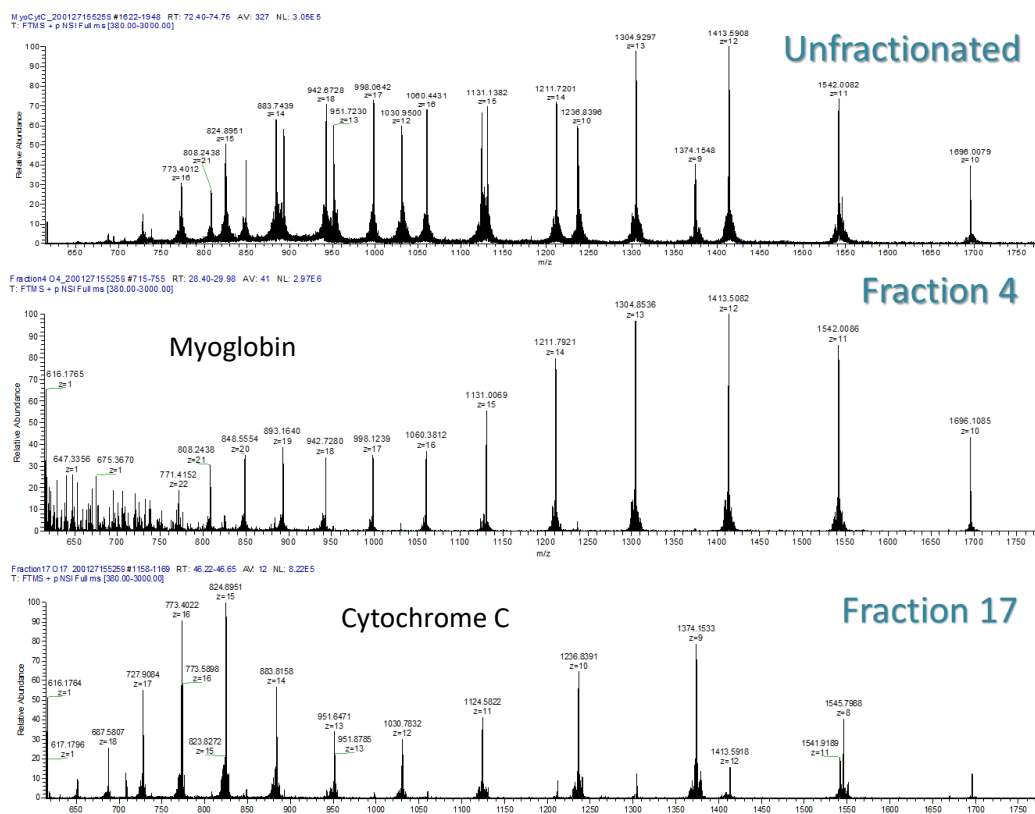

Figure 5.3. ESI MS analysis of pi-Trap fractions containing Myoglobin and Cytochrome C.

The Automated pi-Trap instrument consists of two units. An OEM autosampler (Alias, Spark Holland) and a pi-Trap Cell Unit. Each of these units will have its own dedicated graphical user interface (GUI), which are communicating in the background via highly reliable contact-closure and TTL signals. The Automated pi-Trap Software Package will control the Injection, Separation, Elution and send the “Start signal” to the Xcalibur™ Software in order to start the Orbitrap MS Acquisition. The OEM Alias autosampler embedded into the Automated pi-Trap instrument will be controlled by Clarity software (DataApex), which will not only control the sample injection and elution but also for sending the “Acquisition Signal” to the mass spectrometer via a simple contact closure signal.

No major obstacles are expected in the development of the Automated pi-Trap Instrument. A prototype version of the pi-Trap was successfully connected to an Alias Autosampler in order to evaluate the compatibility between the systems. These tests demonstrated that Alias Autosampler was capable to maintain the analytical performance of the isoelectric focusing separation.

The design and control of the pI-Trap / Orbitrap combination have been done together with the hardware and software configuration. In this context, the following steps have been completed or they are schedule to be executed within the time period assigned for the present package:

- Instrument Specifications - Hardware & Software: **Completed**
- BOM list: **Completed**
- Mechanical Drawings: **Completed**
- Manufacture of the Mechanical Parts: Expected April 2020
- Software Development:
 - Software requirements: **Completed**
 - Electronics & Hardware Requirement gathering for Software implementation. **Completed**
 - Software and Electronic Design. **Completed**
 - Design and Manufacture of a dedicated Printed Circuit Board (PCB): **Completed**
 - Implementation or coding. Expected February 2020
- Testing. Expected April 2020
- Installation and Troubleshooting. Expected July 2020
- Assembly and off-line testing of the pI-Trap: Expected July 2020
- Prototype installed for pI-Trap-ESI: Delivery by August 2020

Task 5.4 Testing the pI-Trap-Orbitrap combination for proteins (BM, KI, TF, IP; M20- 24)

Action 5.4: This task will be done in conjunction with partners KI, IP and TF. The testing will take place at the Karolinska Institutet on samples from IP and KI. The task will be performed between July and August 2020.

1.2.6 Work package 6

Task 6.1. Description: *“Installation of a loaned Q Exactive instrument to Fasmatech to support Omnitrap development A Q Exactive HF instrument will be configured to be interfaced to Omnitrap by removing the charge detector on the back of the HCD cell and adding functionality of ion transfer to and from the Omnitrap. Once the instrument is shipped and installed at Fasmatech, dedicated trigger signals will be provided to initiate the operational sequence of the Omnitrap. Software training and support will be provided to Fasmatech and Spectroswiss in order to fulfil corresponding tasks of the project. This instrument will be focused on optimizing Omnitrap functionalities.” – Task is completed.*

Action 6.1: A Thermo Scientific Q Exactive HF mass spectrometer was delivered to Fasmatech (**Figure 6.1**) and then in the summer of 2019 the omnitrap platform was added to it as the next step towards further deliverables of the project (**Figure 6.2**).

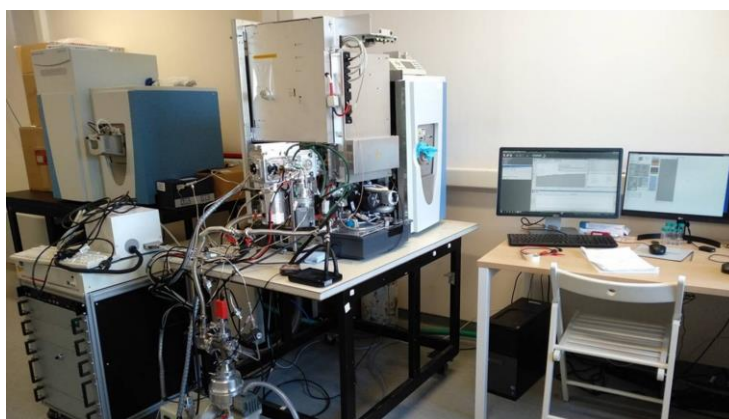

Figure 6.1. Q Exactive HF (instrument to the left) following delivery to Fasmatech.



Figure 6.2. Q Exactive HF interfaced with the Omnitrap.

Initial difficulties with Source turbopump were overcome by improved ventilation of the instrument. Instrument passed standard acceptance specifications, making it available for Omnitrap installation. Further modifications towards project needs include extension of the mass range of Orbitrap detection towards $m/z > 10,000$ to cover intact native proteins, especially intact antibodies sprayed under native

conditions. Joint experiments on the combined hybrid instrument took place in January 2020 at Fasmatech site.

Task 6.2. Description: *“Modified Orbitrap Q Exactive HF X delivered and installed at KI – protocol. In parallel to Task 6.1, a standard Orbitrap Q Exactive HF-X (or a similar high-end instrument) will be modified to improve its performance for desolvation and transmission of intact antibodies. Based on research using Q Exactive UHMR and standard HF-X instruments, there is clearly a reserve for optimizing the desolvation region of the atmosphere-to-vacuum interface that deserves a more detailed exploration. In parallel to this, a joint work with Spectroswiss and Fasmatech will be started on integration of instrument control software using application programming interface (API) to be provided by TF. This work includes also development of tuning and calibration procedures specific for antibody analysis in order to ensure best top-down performance, integration of data for all fragmentation methods and cross-section measurements. After testing of all functional units, the resulting instrument will be delivered and installed at KI and performance protocol will be completed for a test set of compounds.”*

Action 6.2: Work on Task 6.2 was initiated from the selection of a most appropriate instrument for installation at partner KI. As Thermo Scientific Q Exactive HF-X mass spectrometer gets superseded by the new Orbitrap Exploris 480 instrument (www.thermofisher.com/order/catalog/product/BRE725532), it was proposed that the new instrument is also based on this latest product. In addition to major general features like increased robustness, higher resolution and easier access for service and Omnitrap upgrade, Exploris 480 also has the field-asymmetric waveform ion mobility (FAIMS) front-end option, which opens new capabilities for additional specificity of analysis.

While most of functionality is transferrable from Q Exactive HF to Orbitrap Exploris platform, some increase of project scope will be addressed by joint efforts of Fasmatech and Thermo Fisher Scientific.

1.2.7 Work package 7

Task 7.1 Develop data acquisition system (FTMS Booster) for protein top-down analysis (SPS: the lead, performs the task using SPS infrastructure and personnel, M1-M14)

Action 7.1. Top-down and middle-down analysis of large proteins (*e.g.*, antibodies) is performed using either direct infusion mass spectrometry or mass spectrometry on-line hyphenated with some type of preliminary separation (*e.g.*, liquid chromatography, capillary electrophoresis or isoelectric-point separation). For both top-down and middle-down approaches, we have identified a primary requirement to perform ion detection on the Orbitrap FTMS over extended periods of time - up to 2-3 seconds. This is needed to unlock the ultra-high-resolution (UHR) and high mass accuracy capabilities of the Orbitrap FTMS, allowing successful assignment of fragments of mAb antibodies in convoluted, top-down mass spectra. Additionally, these long transients will be necessary in order to evaluate our hypothesis on product ion deconvolution, which relies upon the differences in product ion decay rates in transients for ions in different charge states.

Other performance requirements will include optimization of the sensitivity and dynamic range of Orbitrap FTMS measurements, for both intact proteoform analysis (detection of low abundant proteoforms) and low-abundance product ion isotopic envelopes.

Finally, design and implementation requirements for hyphenation of external data acquisition systems with the Orbitrap FTMS instrument models aimed for inclusion into TopSpec platform. These requirements include consideration of triggering program and time synchronization between the internal and external clocks of the instrument. Importantly, due to the extremely stringent requirements for the accuracy of ion signal detection – the one that would allow artifact-free phase function recording – all these technical requirements should be met exceptionally accurately. According to the project updates, there will be a need to install FTMS Booster TD not only on a Q Exactive Orbitrap FTMS series of the instruments but also on a substantially different (in regard to interface design) newer mass spectrometer – Exploris 480 Orbitrap FTMS. However, the latter appears as a minor risk and will be mitigated by collaboration with the key players – Fasmatech and TFS.

Based on these needs, we have undertaken initial development, testing, implementation, and evaluation of a high-performance data acquisition subsystem (DAQ) dedicated for the use in TopSpec platforms, which we refer to as the FTMS Booster TD. The device is based on the high-performance data acquisition architecture as pioneered by Spectroswiss for data acquisition from FTMS instruments, such as Fourier transform ion cyclotron resonance mass spectrometers, **Figure 7.1**. The difference is in the firmware updates (real-time processing with LabVIEW of an embedded field-programmable gate array, FPGA), specific adaptation of system characteristics (*e.g.*, frequency bandwidth), increased data storage space (up to 16 TB SSD) allowing uninterrupted data acquisition, and triggering program update for specific Orbitrap instruments to be used as parts of TopSpec platforms. Further development of FTMS Booster TD is on-going with additional real-time processing being compiled to be performed on an additional FPGA unit that has been added to a prototype FTMS Booster TD. The aim is to speed up the calculations even further and to reduce the usage of CPUs for transient data processing, which will substantially increase the speed of the calculations (FPGAs can perform these calculations much faster).

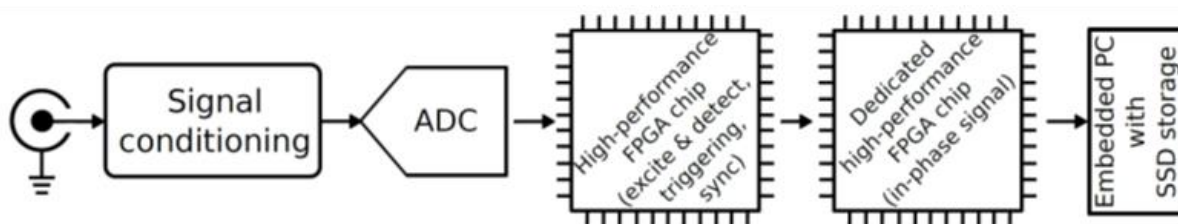

Figure 7.1. Prototype FTMS Booster TD: (top panel) shows new-generation type architecture of this high-performance data acquisition system; (bottom panel) shows a general picture of a device and its installation on a Q Exactive UHMR Orbitrap FTMS performed at a TopSpec partner site (TFS, Bremen, Germany). The interface of connecting FTMS Booster TD to an Orbitrap FTMS is visible at the right bottom corner – it includes 2 signal cables originating at the pre-amplifier of an Orbitrap and a trigger cable that operates the FTMS Booster TD as a guest system, whereas Orbitrap acts as a host.

With the prototype FTMS Booster TD in hands, we have developed and have begun testing specialized workflows to allow the combined Orbitrap-Booster TD system to operate efficiently and realize the benefits that the combination allows (*e.g.*, long transients, parallel operation, *etc.*). To enable integration of FTMS Booster TD into TopSpec platform and allied data processing/analysis routines, we have evaluated FTMS Booster TD on the following Orbitrap FTMS platforms:

Set-up 1. FTMS Booster TD hyphenation to a Q Exactive HF with HCD (at Spectroswiss partner laboratory at the EPFL campus in Switzerland).

This implementation and allied method development allowed to acquire top-down MS data of a number of proteins when HCD (higher energy collision dissociation) is employed. Importantly, we managed to detect ions in a longer period of time and acquired up to 6 seconds transients, see **Figure 7.2**. That supported further data processing/analysis of top-down data to evaluate importance of: (i) ultra-high-resolution (UHR) TD MS and (ii) product ion transient decay rates approach (see below). The required method development and FTMS Booster TD firmware updates were performed.

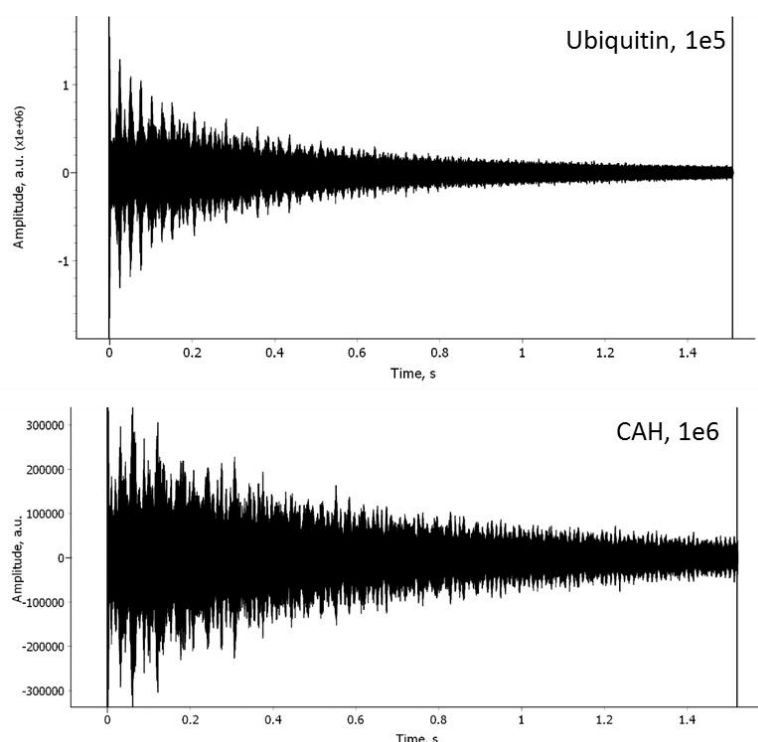

Figure 7.2. Extended duration transient acquisition on a Q Exactive HF Orbitrap FTMS equipped with FTMS Boosted TD. Shown are transients of (top panel) ubiquitin and (bottom panel) carbonic anhydrase. Note that the maximum allowed transient duration for these instruments is 512 ms transients (corresponds to 240k @ m/z 200 resolution setting). Therefore, the thus acquired transients surpass the state-of-the-art. Importantly, they demonstrate that product ion motion, even in complex top-down ion populations, can be coherent over these extended periods of times. On the other hand, these results clearly show a decay of ion signals in these transients, which is why these transients were employed for product ion decay rate calculations (see below).

Set-up 2. FTMS Booster TD hyphenation to a Q Exactive UHMR (at Thermo in Bremen, Germany). A joint work with a TopSpec partner, TFS.

This implementation and allied method development allowed to acquire intact mass and top-down MS data (HCD) of a number of proteins in an extended mass (m/z) range – enabling hyphenation of transient technology with native FTMS, see **Figure 7.1**. The required method development and FTMS Booster TD firmware updates were performed.

Set-up 3. FTMS Booster TD hyphenation to a Q Exactive with in-beam ECD (at eMS-ion, Inc. in Corvallis, OR, USA).

This implementation and allied method development allowed to acquire intact mass and top-down MS data of a number of proteins when ECD (electron capture dissociation) is employed, **Figures 7.3** and **Figure 7.4**. The required method development and FTMS Booster TD firmware updates were performed. The importance of the acquired datasets is in the general interest of TopSpec platform to employ ECD-type MS/MS approaches. Therefore, earlier acquisition of ECD-based top-down MS data is useful for accelerated development of data processing and data analysis methods. Note, capabilities of the Omnitrap are significantly wider than of the in-beam ECD cell commercialized by eMS-ion. Furthermore, ion-electron interactions are realized differently.

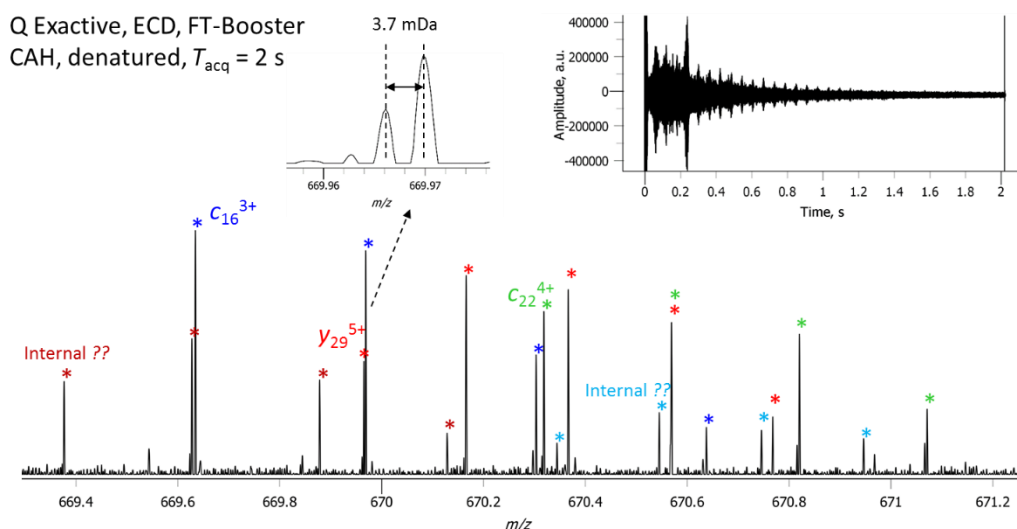

Figure 7.3. Achieving ultra-high-resolution with in-beam ECD on a Q Exactive Orbitrap FTMS equipped with a high-performance data acquisition system, FTMS Booster TD. The acquired transient data was submitted for product ion decay evaluation.

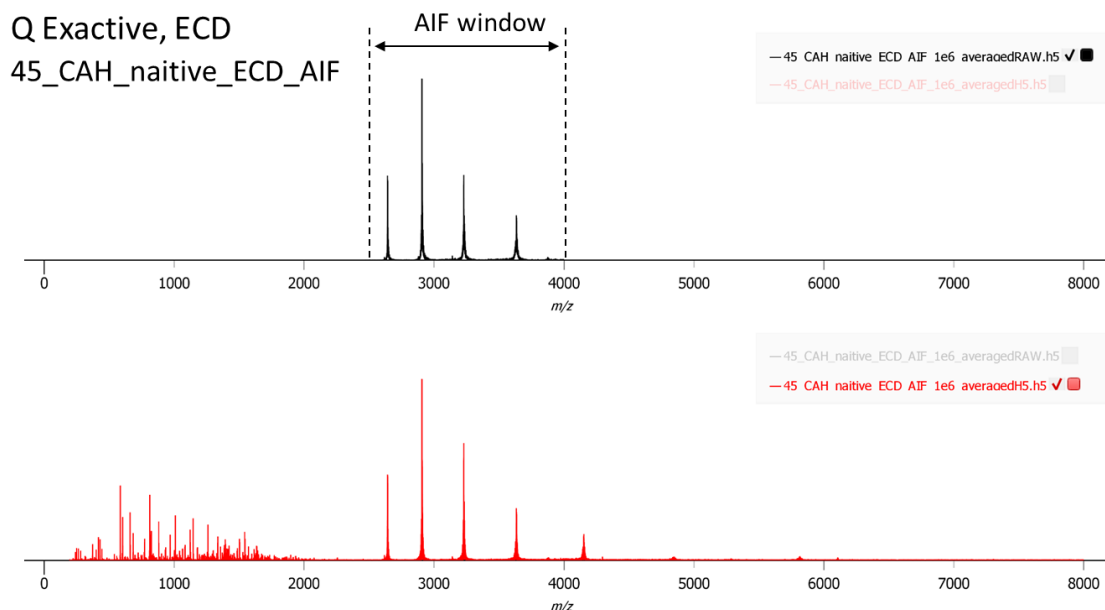

Figure 7.4. Implementation of ECD performed on a population of protein precursor ions prepared following native FTMS procedures. The prototype FTMS Booster TD was instrumental to enable this operation of Orbitrap instrument (via all ion fragmentation module, AIF): (top panel) shows that Orbitrap itself (.RAW mass spectra) does not visualize the ions of interest, whereas (bottom panel) FTMS Booster TD records complete transient and allows to detect product ions in native ECD mode.

Set-up 4. FTMS Booster TD hyphenation to a Q Exactive UHMR with UVPD and native FTMS (at University of Texas at Austin, TX, USA). A collaborative work with a potential TopSpec platform future user.

This implementation and allied method development allowed to acquire intact mass and top-down MS data of a number of proteins when both UVPD (ultra-violet photodissociation) and native FTMS are

employed. The required method development and FTMS Booster TD firmware updates were performed. Importantly, UVPD of mAbs and their subunits was obtained upon both denaturing and native ESI conditions. The obtained data is of importance for further development of TopSpec platform and allied data processing and data analysis software.

On-going and future actions: we will complete these developments and optimization of the initial prototypes for TD MS applications within the allocated project time. We will install, as scheduled, two prototypes in the labs of the corresponding participating groups, which will enable us to fully address the follow up tasks.

There are no deliverables/milestones associated with task 7.1 during the reporting period M1-M12.

Task 7.2 Develop a transient-based decay constant deconvolution approach (SPS: the lead, supervision and main development, TNTU: support for related data analysis software development, KI: support for fundamentals and vision of the approach development and applications, M4-M12)

Action 7.2. The main hypothesis behind this action is that product ion decay rates may be used to fractionate the over-complex and congested product ion mass spectra in TD MS. As a result, hidden below each other protein ion isotopic envelopes could be revealed, leading to more robust charge state deconvolution and hence to more accurate analysis of TD mass spectra, yielding increased (and more confident) sequence coverage. In the past, decay rate methods were employed in FTMS (both ICR and Orbitrap) to separate precursor ions of large proteins. Here, we proposed performing decay rate analysis on product ions in TD mass spectra. To explore this idea, we used experimentally obtained transients, of extended duration, from Orbitrap FTMS instruments (available at Spectroswiss) - employing results from testing the FTMS Booster TD subsystem from Task 7.1. We then developed three approaches to evaluate the degree of product ion decay during ion detection and estimated its value for improving sequence coverage, see below.

Approach 1. Sliding window transient processing. This is a direct approach which compares product ion distributions from different parts of transients submitted for FT processing. For example, we estimated the differences in product ion distributions between the initial halves of long (1-2 second) transients and the second halves of the same transients. The results demonstrated that indeed these top-down mass spectra differ. Thus, we developed a sliding window approach, where we took a window of 500 ms (that would allow resolving product ion isotopic distributions) and performed FT processing for this window when it slides along the transient from its start with small, 1-10 ms, steps, until it reaches the end of the transient. As a result, we received 3D diagrams showing product ion behavior along the transient (basically as it changes during ion detection), see **Figures 7.5-7.7**.

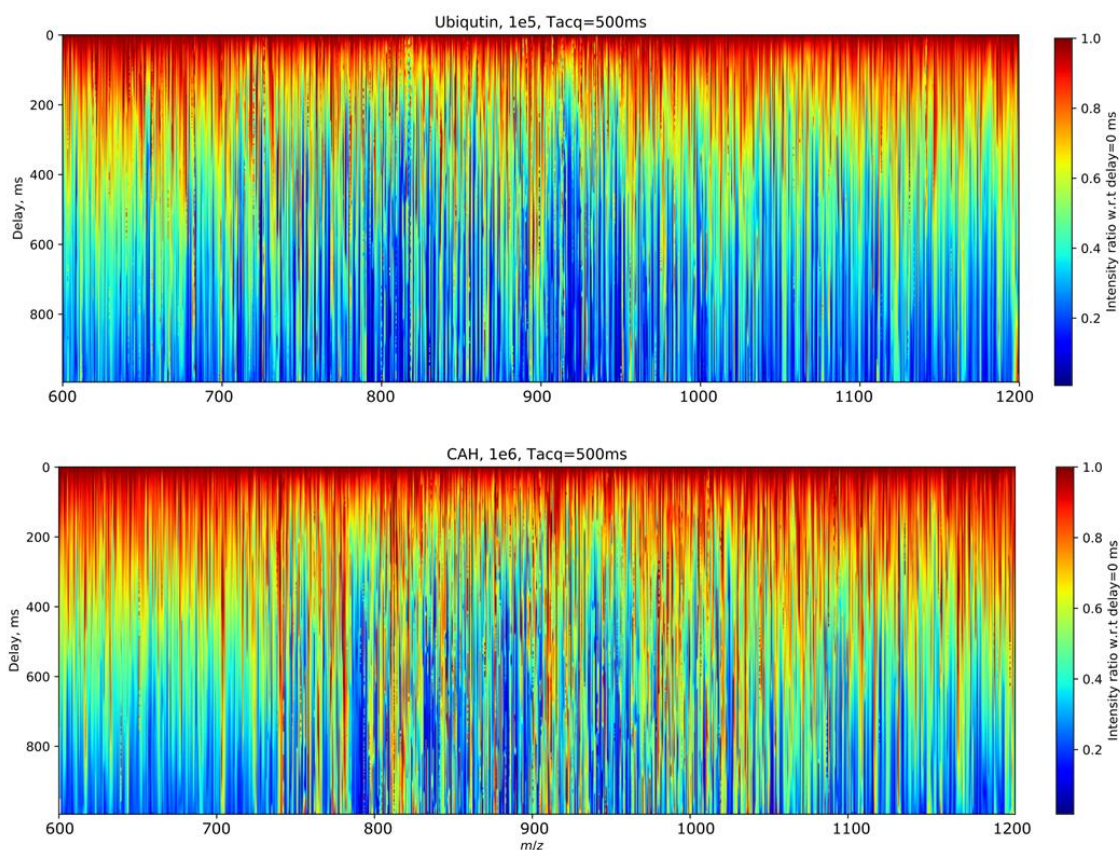

Figure 7.5. Product ion intensity along the transient (ion detection time) for data processing window of 500 ms and sliding window step of 10 ms. Results shown are for (top panel) ubiquitin and (bottom panel) carbonic anhydrase proteins, as acquired with FTMS Booster TD on a Q Exactive HF. Data shown corresponds to the transients shown above in **Figure 7.2**. Color scale show product ion intensity relative to the intensity of the same product ions for the first window (no sliding). The horizontal axis is the m/z scale, and the vertical axis corresponds to the steps along the transient. Clearly, product ions demonstrate different behavior.

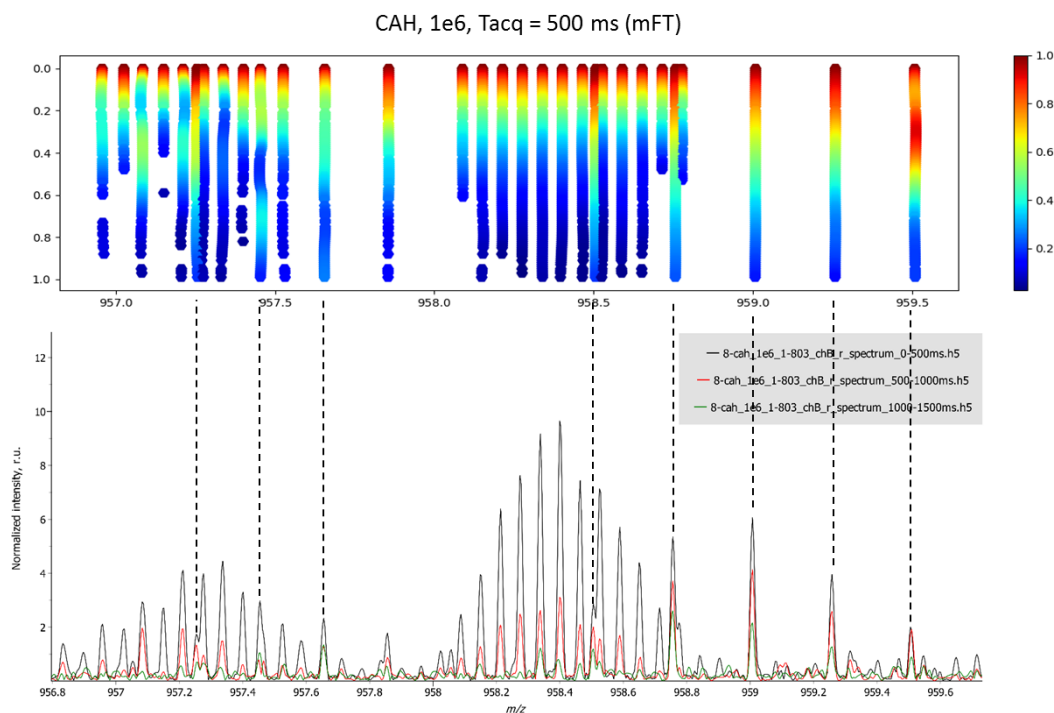

Figure 7.6. Application of product ion decay rate concept to carbonic anhydrase analysis. (Top panel) shows an expanded view into product ion “mobilogram” from **Figure 7.5** (carbonic anhydrase example). (Bottom panel) shows product ion isotopic envelopes obtained from three different parts of a transient: 0-500 ms (shown in black); 500-1000 ms (shown in red); and 1000-1500 ms (shown in green).

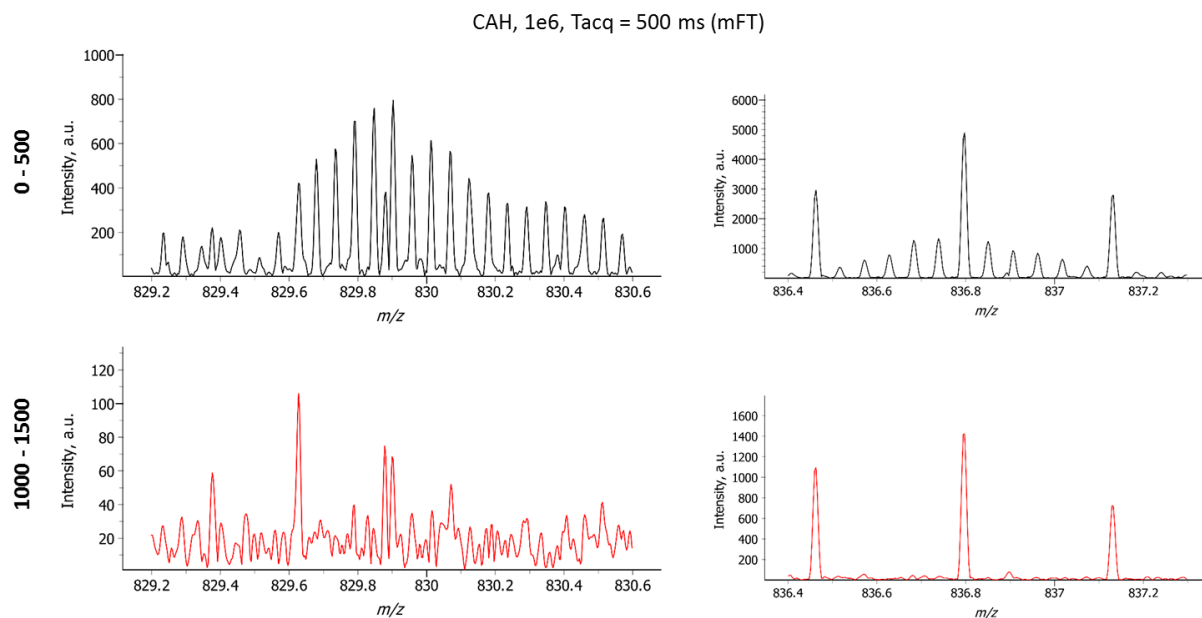

Figure 7.7. Examples of product ion deconvolution from top-down mass spectra of carbonic anhydrase, when different regions of transients are processed: (top panel) shows results from processing 0-500 ms of a transient and (bottom panel) shows processing results from 1000-1500 ms of a transient.

The most evident conclusion from **Figures 7.5-7.7** is that the more multiply charged product ions decay faster than the less charged product ions. And that allows to more clearly detect the overlapping product ion distributions. Therefore, an attempt can be made to decouple the product ions based on their charge state and to estimate an impact from this approach on sequence coverage, **Figure 7.8** and **Figure 7.9**.

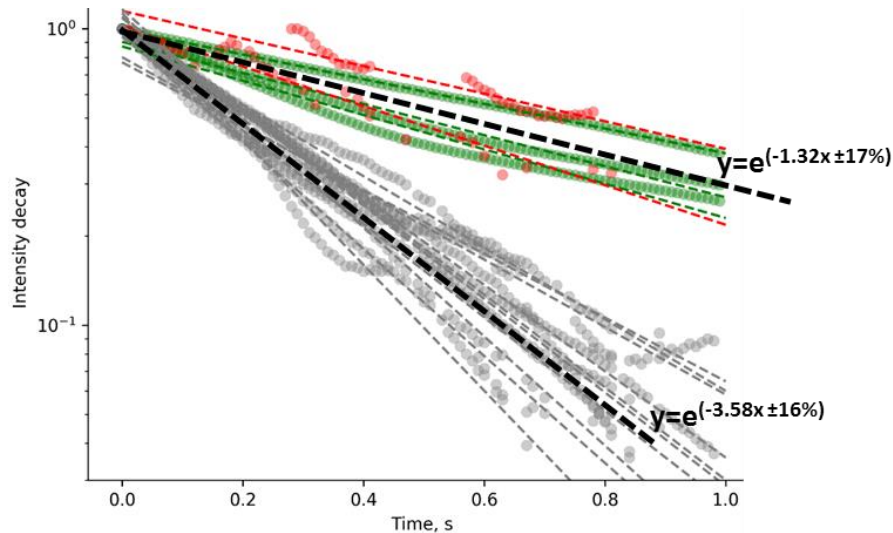

Figure 7.8. Deconvolution of product ion isotopic envelopes illustrated in **Figure 7.6** by plotting their intensity decay as a function of ion detection time. Product ions belonging to the same isotopic envelopes decay at about the same rate, whereas product ions from envelopes with different charge state decay at different rates.

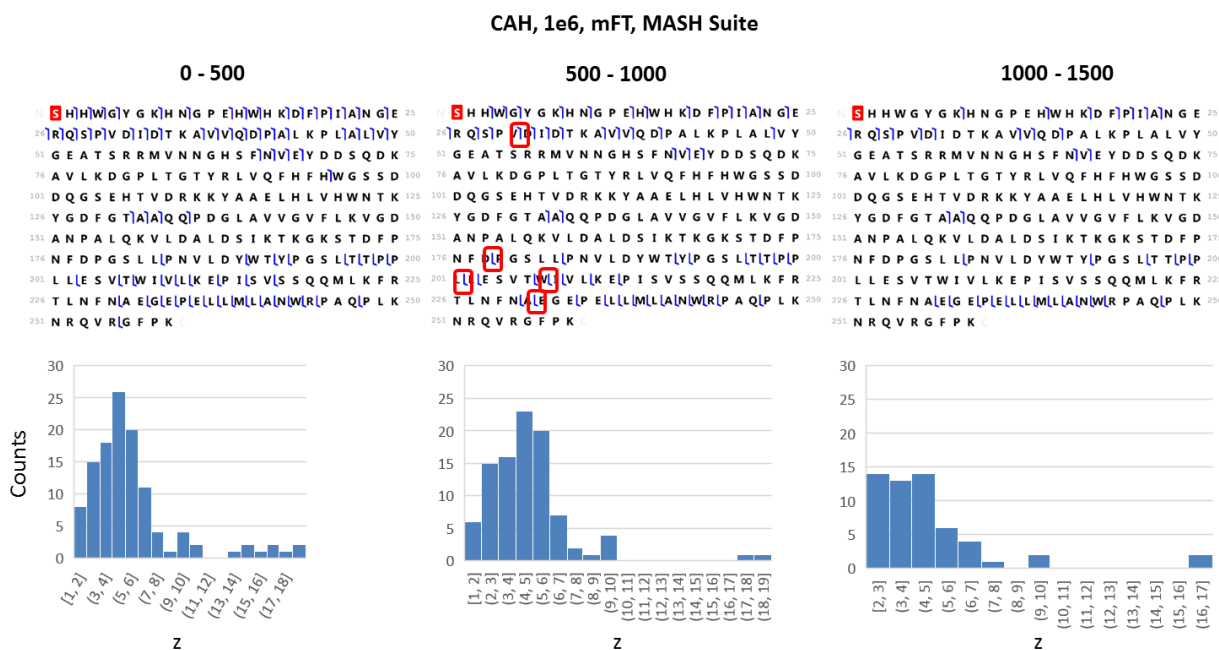

Figure 7.9. Sequence coverage maps of carbonic anhydrase (HCD on a Q Exactive HF) for the different transient regions: 0-500 ms, 500-1000 ms, and 1000-1500 ms. Histograms show product ion distribution as a function of charge state.

Overall, results of this approach qualitatively demonstrate the differences in product ion behavior exhibiting noticeable differences between product ions in different charge states. The approach is relatively simple in realization and can be quickly applied to results from different platforms, **Figure 7.10**.

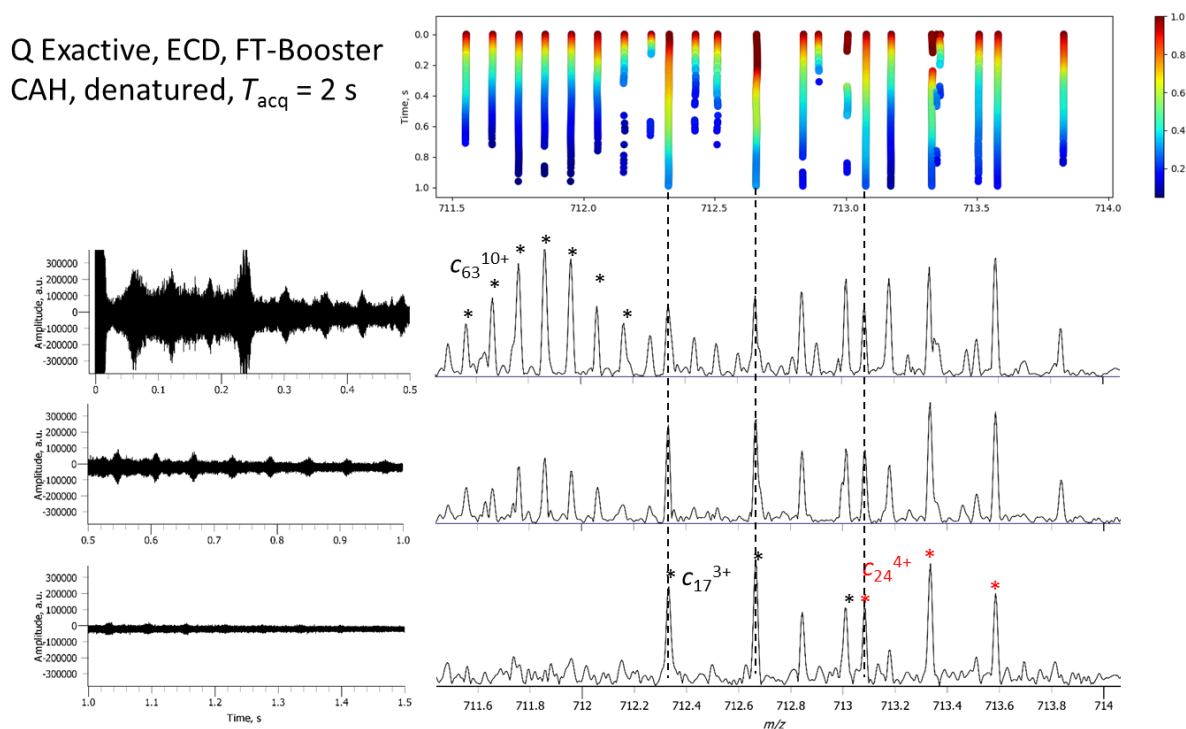

Figure 7.10. Product ion decay rate concept submitted to sliding window approach for top-down data acquired with a carbonic anhydrase on a Q Exactive Orbitrap FTMS equipped with in-beam ECD (data acquired at eMS-ion, Inc. in Corvallis, OR, USA).

However, the obtained results may not be revealing the maximum information, as well as do not provide clear quantitative description. Therefore, we continued to reveal the potential of this approach by alternative routes, see below.

Approach 2. Asymmetric apodization window processing. The fundamentals of FT processing tell us that processing different regions of a transient can be performed without transient clipping but with simply changing the apodization function parameters, *e.g.* the shape of the apodization window which can be achieved via changing the F value, **Figure 7.11**. The construction of the asymmetric apodization function is explained in <https://doi.org/10.1002/rcm.7190>. F corresponds to the position, relative to the transient length, where the apodization function reaches its maximum. Therefore, when $F=0.1$, the apodization maximum is 10% of the way along the transient.

There are specific benefits of this approach compared to the one above: (i) no need to perform transient processing in regard of slipping a certain window; and (ii) the first data point is always the first data point of the transient, which means that the absorption mode FT can be applied, whereas if we consider a transient window without the beginning portion of a transient – then the absorption mode FT may become not applicable, and only magnitude mode FT could be realized, which results in resolution reduction by a factor of 2.

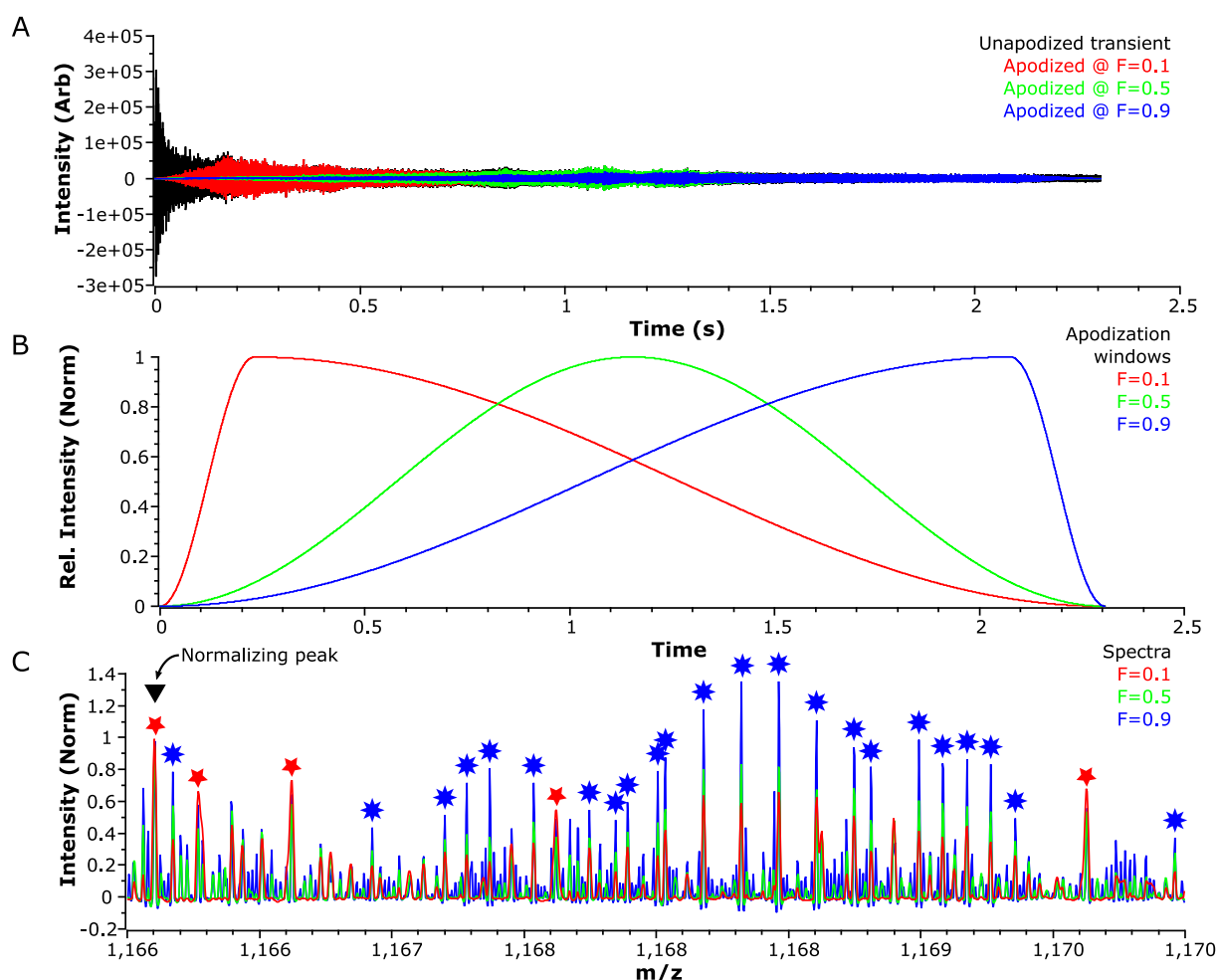

Figure 7.11. A) A transient shown unapodized and apodized with 3 different values of F for the asymmetric apodization: 0.1, 0.5 and 0.9, emphasizing, respectively, the beginning middle and end portions of the transient. B) the apodization functions used to generate the asymmetrically apodized transients. C) A section of the (normalized) mass spectra (of myoglobin) resulting from the different apodizations. Peaks labelled with a red star are emphasized early in the transient whilst peaks labelled with a blue star are emphasized (relatively) towards the end of the transient.

Application of the F-approach to the top-down data acquired on proteins with up to carbonic anhydrase size reveals sequence coverage improvements similar to the sliding window approach. As we believe these benefits are minor, we continue to develop both of these approaches as well as investing into a more sophisticated and computationally heavy approach, spearheaded by KI.

Approach 3. Decay rate-based mass spectra fractionation.

The work on this approach is on-going and up to date the results obtained demonstrate that the “resolution” of about 5 (similar to an ion mobility resolution definition) could be obtained on top-down data as depicted in **Figure 7.2**.

In summary, our work on these three approaches detailed above is progressing as stated in the task description, involving all the envisioned participants. We believe that attempting multiple strategies in pursuit of this deconvolution goal is the correct approach, at this stage. We may focus down to one or two methods only, in the future, once we can take this decision based on experimental evidence. But,

it is unlikely that this decision point will be reached until we have begun to process data from the completed TopSpec platform, as the benefits are dependent, in part, on spectral complexity; we will not fully understand the spectral complexity until the prototype system is operational, but the initial aspiration of the system design was to create much richer (i.e. more complex) spectra that is currently achievable.

Up to date, we have developed the underlying mathematical algorithms and software to enable transient processing, and to test the initial capabilities of the different transient damping deconvolution approaches. We have tested these methods on initial sets of TD MS data, of two model proteins (ubiquitin (8.6 kDa) and carbonic anhydrase (29 kDa)), performed using HCD MS/MS on a Q Exactive HF (transient length of 1.5 s, which exceeds the commercially available duration of ion detection). In addition, we acquired ETD MS/MS data from a F(ab) subunit of Trastuzumab (50 kDa), but with a limited transient length (250 ms).

The results obtained, using all three approaches, confirm the general applicability of the idea – product ion envelopes of (sufficiently) different charge states can be baseline resolved using their decay rates. As product ions in TD mass spectra range from low charge states (1-3 charges) to high charges states (6-8 charges and above), it is indeed possible to detect ion motion for a period of time sufficient for higher charged product ion signal to decay whereas the low charge state product ions still perform coherent motion and produce ion signals. Fractionation of complex TD mass spectra of ubiquitin and carbonic anhydrase shows some increase in sequence coverage, but only on the order of 1-3%. Results obtained demonstrate that further increase in efficiency of the method is needed to achieve a practically attractive implementation (sequence coverage increase by 20% and more).

We expect that larger proteins (including mAb subunits, 25 and 50 kDa, and whole mAbs, 150 kDa), fragmented using more efficient tandem MS methods, will produce more densely populated TD mass spectra and may demonstrate higher increase of sequence coverage even for the achieved resolution (5). Furthermore, our analysis of the underlying limiting factors for “mobility” resolution provided by decay rate demonstrate that there remains room for improvement by more sophisticated transient data processing.

Our objective is to achieve a “mobility” resolution of about 10 and to apply it to extended duration transients (1.5-2 s) from larger proteins (25-150 kDa). We will be able to evaluate this method once the TopSpec platform is in place.

Milestone MS1: Demonstrated effectiveness of product ion isotopic distribution deconvolution.

As discussed above, we can report now that, in general, we have achieved this milestone by developing the allied approaches and demonstrating the effectiveness of product ion isotopic distribution deconvolution by decay rates. However, to increase the practical value and importance of this method, we will continue developing our data processing and data analysis software (within the frames of the follow-up Tasks) and will apply the optimized methods to experimental data acquired, over the course of the next 6-12 months, from the completed TopSpec platforms (equipped with FTMS Booster TD devices).

Task 7.3 Develop data processing software for protein top-down analysis (SPS: the lead, development and implementation of time-domain data (transients) processing aiming for protein analysis; TNTU: support for related data analysis software development, KI and IP: software specifications formulation, software evaluation, M1-M18)

Action 7.3. In line with actions taken for Tasks 7.1 and 7.2, our consortium is developing two packages that will support transient processing for TD MS – one developed in the Python programming language (Spectroswiss) and one developed in the LabVIEW environment (TNTU). The on-going work corresponds to the current needs of the project. The software packages will be evaluated by KI and IP once the corresponding TopSpec platforms will be installed. During the reporting period, SPS and TNTU engaged in software specifications formulation with KI and IP, as planned. The reason to develop the two software tools is due to the complementarity of these approaches and of the software development methods employed. It is envisioned that (closer to the project end) these two methods maybe integrated into a single software tool that will be based on the more flexible and easier to use one.

Top-down protein (antibody) specific data processing methods include:

Approach 1. Increased sensitivity by stitching of narrow m/z windows of top-down mass spectra to yield a complete, broadband, top-down mass spectrum. Benefits from using transients are in the optimized noise analysis/consideration between the narrow m/z windows. Expected benefits are in increased dynamic range and improved product ion detection and assignment.

Approach 2. Increased sensitivity by averaging transient (unreduced) data from multiple technical replicates not only in top-down mass spectrometry (single protein analysis) but also in top-down proteomics (analysis of complex mixtures of proteins).

Approach 3. Using the data acquired using Spectroswiss infrastructure, we continue to evaluate an alternative (to decay rate) approach of ultra-high resolution (UHR) Orbitrap FTMS application for resolving the ultra-complex product ion distributions in TD mass spectra. In a combination with detection of product ions in narrow m/z windows (SIM windows), followed by SIM stitching of transients and/or mass spectra in data processing/analysis software, this approach may allow to not only increase the sensitivity of product ion detection, but also to ensure longer ion lifetime when transients of extended duration are recorded (thus UHR performance). The preliminary results obtained are encouraging.

Task 7.4 Evaluating the FTMS Boosters in protein top-down analysis in a laboratory environment. (SPS: the lead, supervision and support of the evaluation procedure, optimization and facilitation of FTMS Booster connectivity to the Orbitrap platforms on-site at KI and IP, troubleshooting; KI and IP: perform experimental evaluation of the FTMS Boosters in their laboratories, M19-M34)

Action 7.4. This task will start in M19.

Task 7.5 Development of the top-down data analysis software optimized for Abs (TNTU: the lead, SPS: support for related data analysis software development, interfacing data processing and data analysis software architectures and tools, FASM, KI and IP: software specifications formulation, and software evaluation, M1-M29)

Action 7.5. Joint work from TNTU and SPS is on-going. The SPS team has provided both experimental and simulated data for data processing and data analysis software development and performance evaluation. The TNTU team has substantially progressed the development of a targeted LabVIEW-based software tool for addressing the needs in top-down data analysis. Over the period M1-M12, the following tasks have been completed:

- Development of a new, faster peak picking algorithm, AutoPiquer 2.0, which will increase the rate of data processing for larger datasets. This algorithm includes a variety of improvements, including the ability to detect the presence of, and then preferentially use available graphical processing units (GPUs). Speed increase is approximately 6-fold over the previous algorithm (AutoPiquer 1.0). This algorithm will be further developed over the next 12 months.
- In silico digestion capability for streamlined production of middle down libraries for antibodies. This capability is intended to improve our ability to routinely create libraries for TopSpec. The user interface modifications are highlighted in 7.12.
- Batch creation of libraries for top and middle down assignment. This improvement is intended to reduce the potential for user errors when creating sets of assignment libraries (as risk exposed during early stage testing) and also allows the generation process to be queued for out of hours running. The user interface modifications for this new feature are also highlighted in **Figure 7.12**.

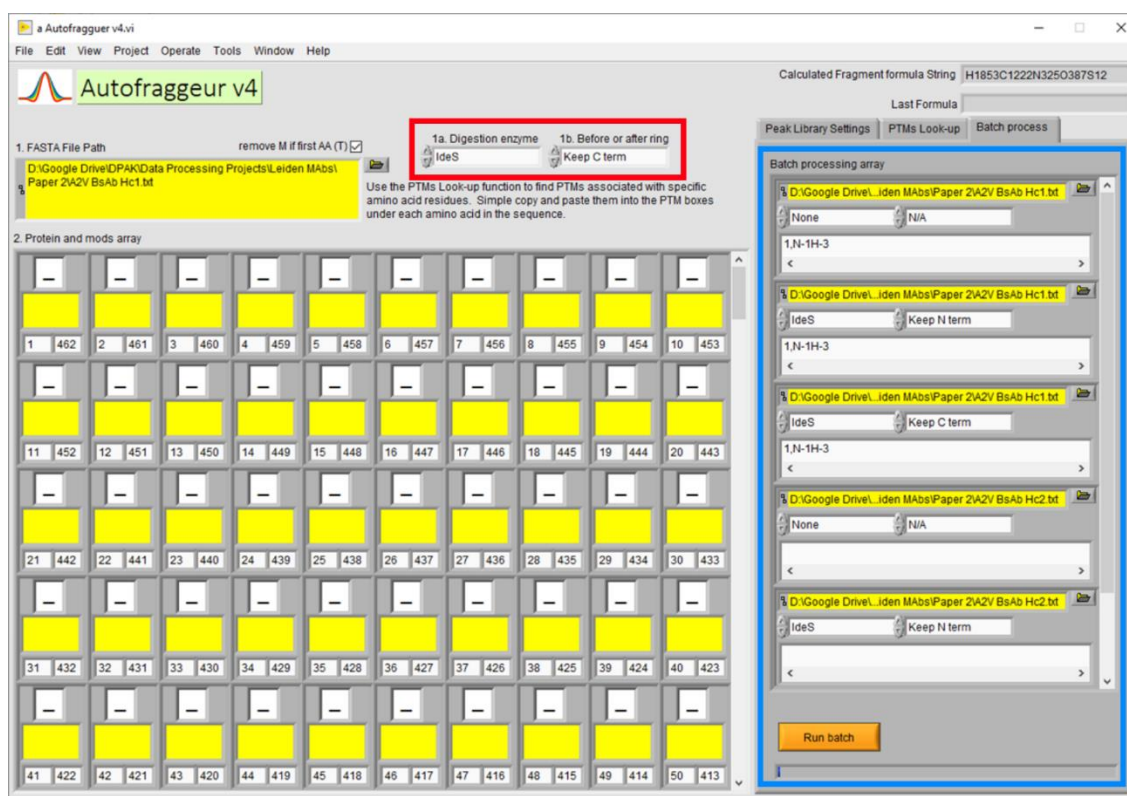

Figure 7.12. AutoFraggeur top-down protein library generation tool, with new functionality highlighted. Red box indicates user controls for middle-down IDEs and GinghisKHAN digestion of mAbs. Blue box indicates user controls for systematic batch generation of libraries.

- The data format of the libraries and TD assignment results files have been upgraded from tdms to SQLite. SQLite file format allows both the libraries and assignment results files to be queried by the SQLite database engine and by freely available SQLite viewer software. As the libraries and results files are now in database format, it is easier to search, combine and contrast multiple sets of results. This was an important new capability that will be required by TopSpec, as the MS system will be capable of multiple different modes of antibody fragmentation and it will be critical to be able to routinely quantify and combine the benefits derived from

multiple different fragmentation approaches. Additionally, we will need the capability to easily detect and identify changes across multiple samples. Finally, unlike the tdms format, SQLite files can be easily accessed in most current programming languages, meaning that it will be easier for other current and future partners to be able to develop their own tools for accessing and using our results. For example, the new SQLIB (top or middle down fragment library) and SQASS (top or middle down assignment results) files can be easily reviewed in freely available SQLite browser software, as shown in **Figure 7.13**.

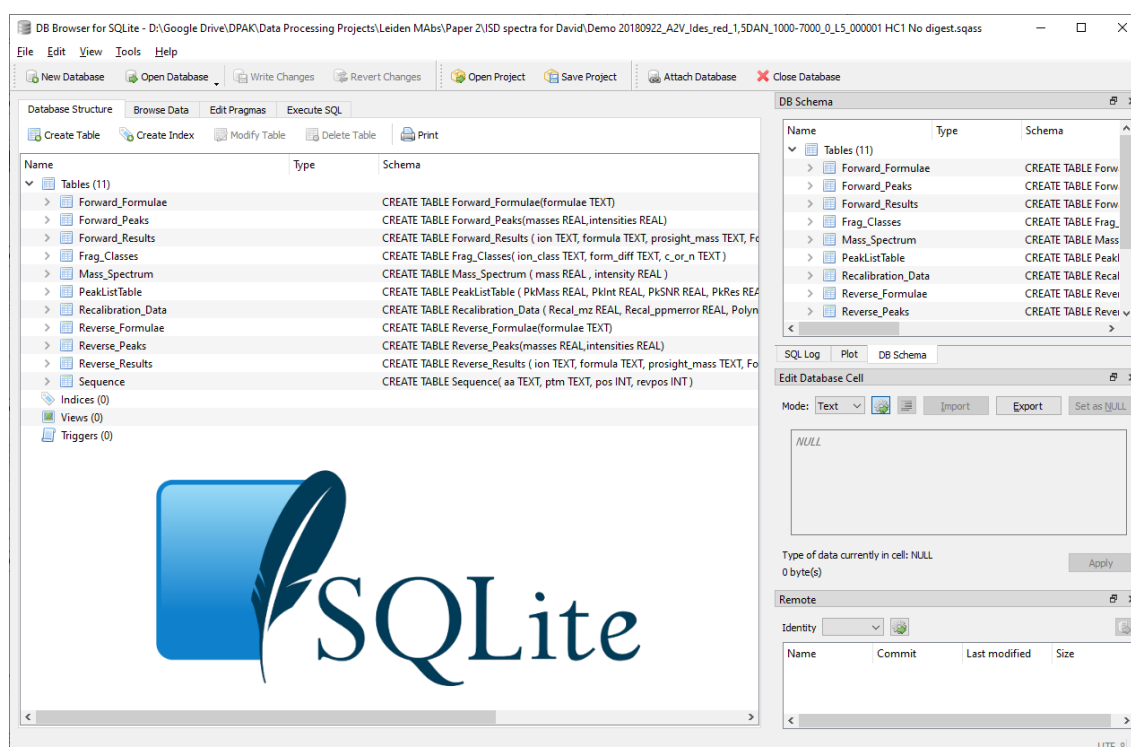

Figure 7.13. Reviewing an SQASS (top or middle down assignment results) file in a freely available SQLite browser.

- Online user curation of results. The assignment system has been upgraded with a basic user curation capability, meaning that users can easily check and discount unlikely putative assignments. An important underlying part of this development was the incorporation of user curation fields in the assignment results database file format. This inclusion was designed to make development of the user curation system much simpler and more responsive, once the Topspec systems' users are more capable of defining their specific requirements.
- MASH suite comparison. The assignment system (AutoSeequer) has undergone a basic benchmarking against MASH Suite Pro – a commonly used top-down assignment tool. The results (and example is shown in **Figure 7.14**) indicate that, for basic use, the assignment tool being developed at TNTU provides results that are comparable to MASH Suite Pro, but with far more advanced additional tools and capabilities, with special emphasis on the developing results combination tools. We will revisit this benchmarking exercise when we begin to get data from the TopSpec system but the current results have confirmed our initial strategy.

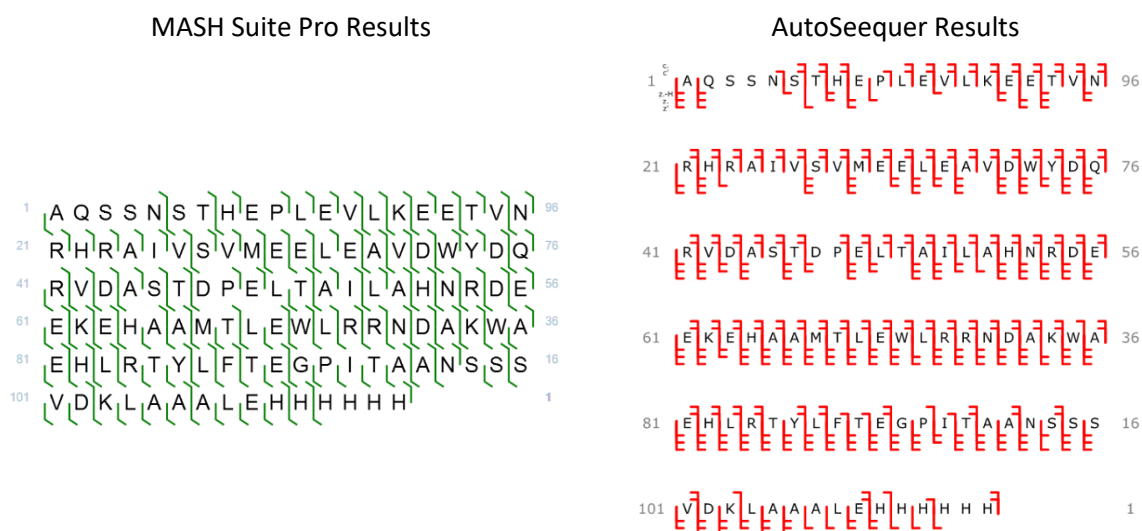

Figure 7.14. Example of benchmarking of AutoSeequer performance for the same dataset – in this case top-down ECD fragmentation of Encapsulated Ferritin.

- Alternative algorithms for providing a figure of merit (FoM) for the quality of the match between the mass spectral peaks and the theoretical isotopic distribution of their mAb fragment assignment were tested. However, this testing process ultimately supported the original Euclidean vector FoM calculation.

Key current directions under this task are:

- Development of a capability to output the processed mass spectra and peak lists as mz5 format files – a common MS interchange format. This capability will be used to ensure that it is easy to export partially processed TopSpec MS data out into other processing workflows.
- Research understanding the impact on assignment and development of algorithms to allow for overlapping isotopic distributions from the same charge state that can commonly arise in protein fragmentation data – e.g. z and z' ions where, from the 2nd isotopologue peak, the z ions peaks overlap with the z' ions.
- mAb *de novo* sequencing will be dependent on high sequence coverage achieved by fragmentation. We are not yet able to judge the levels of sequence coverage that the TopSpec system will be capable of achieving. However, we have every expectation that it will be high. Nonetheless, it seems prudent to seek to improve our capability to robustly detect low signal-to-noise peak clusters, with a view to closing potential sequence gaps. Our initial strategy in this regard will be to investigate the use of machine learning techniques, specifically a convolution neural network method, to further improve the AutoPiquer 2.0 algorithm capability for distilling low signal-to-noise peaks out of spectra.
- Continuing research investigating whether charge state deconvolution is the optimal assignment strategy? There are two approaches possible: (i) charge state deconvolution of complex product ion distributions prior to product ion matching and annotation and (ii) direct matching and annotation of product ion isotopic distribution for multiply-charged precursor ions, without deconvolution. The software under development is being tested on previously collected datasets and on model data generated using Spectroswiss experimental infrastructure, as well as using the simulated top-down mass spectra (generated using the

FTMS Data Simulator tool of Spectroswiss). The latter enables production of close-to-reality transients (and thus, mass spectra) for any complexity top-down mass spectra. We are currently developing a library of quality control top-down mass spectra that will be further used to evaluate the performance of the data processing and analysis tools (as well as comparing their performance to that of other tools available on the market), **Figure 7.15**.

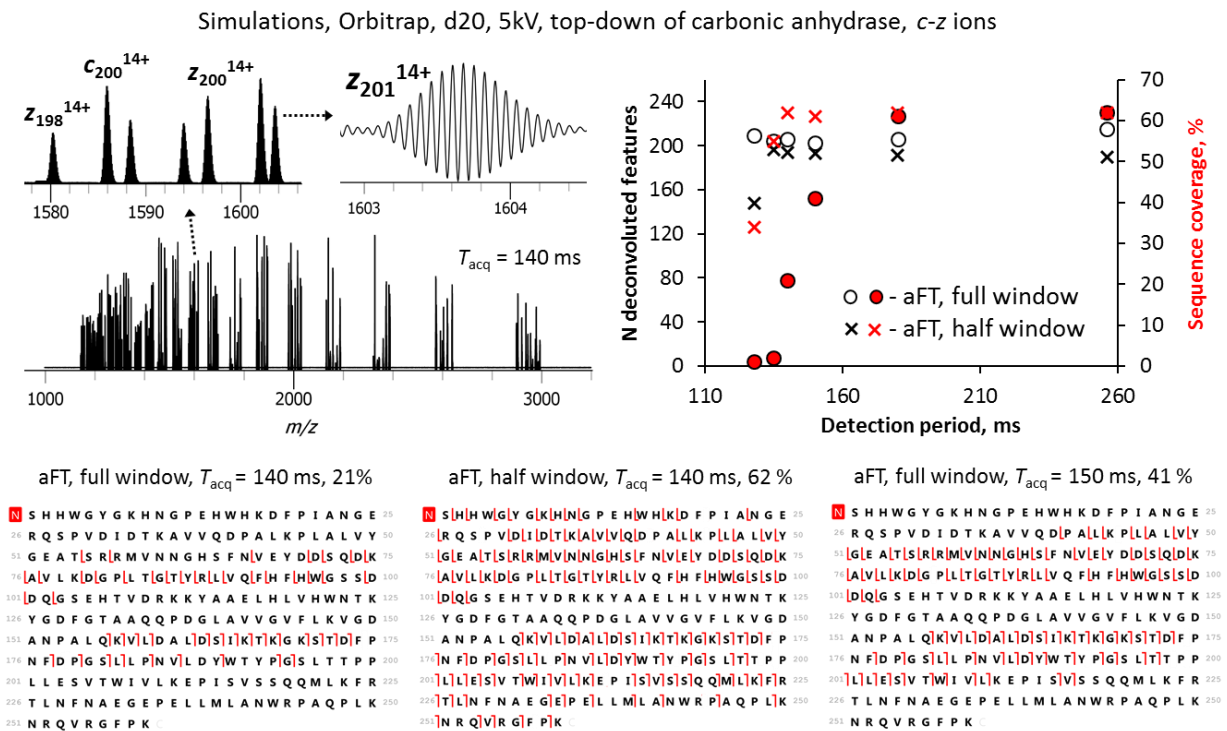

Figure 7.15. *In-silico* top-down mass spectrometry for MS/MS with an Orbitrap FTMS. Close to reality top-down mass spectra can be now generated using tools developed at SPS (via FTMS Isotopic Simulator). The simulated top-down mass spectra can be used for performance evaluation of data analysis software tools as well as for the rational design of top-down FTMS experiments, including data processing pipeline parameters (e.g., apodization window shape, transient length, etc.).

1.2.8 Work package 8

The dissemination and exploitation activities and plan have been described in deliverable: D8.2 Draft Exploitation and Dissemination Plan. This document has been finalized on December 19, 2019 and is available on the TopSpec website – documents: <https://topspec.ki.se/documents/>. In addition this document has been uploaded to the H2020 project portal.

Task 8.1 Dissemination activities. M1-M36. -Creating and publishing the public dissemination material (Website, posters, brochures, videos), - Adapting the dissemination support to the target, - keeping track of publications and public disclosures by creating a database.

Action 8.1 A project webpage (<https://topspec.ki.se/>) has been designed and launched (**Figure 8.1**). The TopSpec website contains current information related to the project, news, documents, obtained results and organized/attended events and will be updated on a regular base. Further is contains the following information:

- Description of project
- Individual work-packages
- Public documents
- Objectives and milestones
- Profile of researchers and project partners
- Events related to the project implementation

A screenshot from the homepage can be seen in **Figure 8.1**.

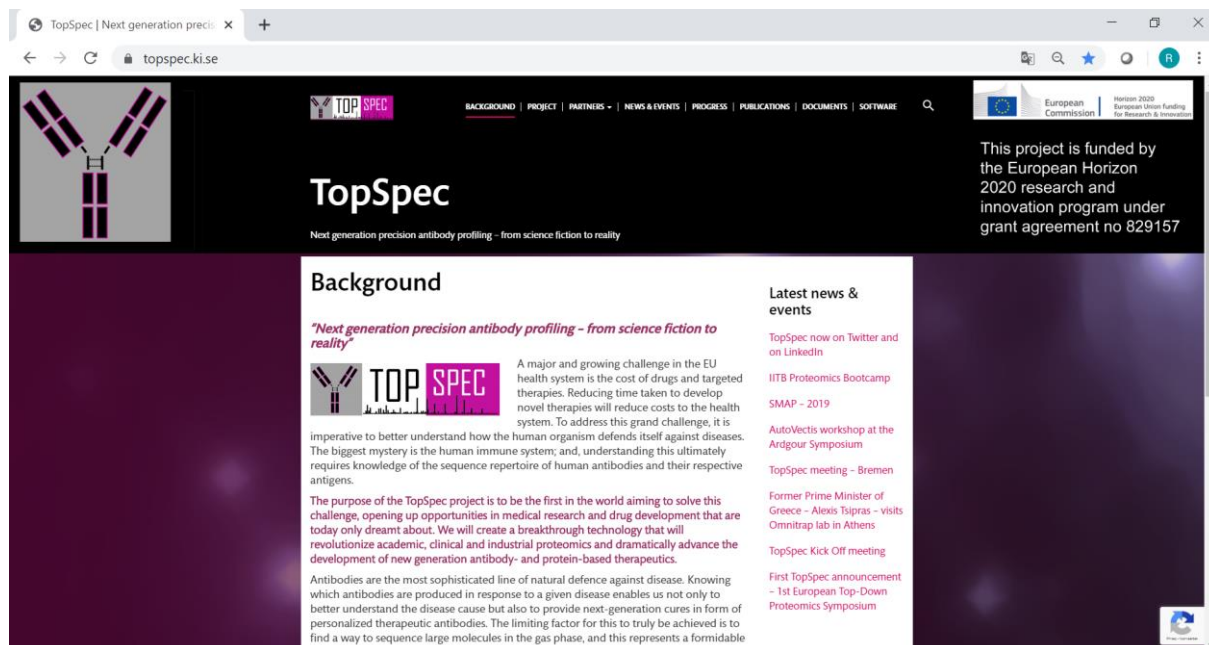



Figure 8.1. Project webpage has been designed and launched (<https://topspec.ki.se/>).

TopSpec website <https://topspec.ki.se/>. All reports that have the “PUBLIC” status can also be found on the webpage under “Progress”.

Several dissemination activities have been undertaken by the TopSpec project partners. These activities are tracked in a simple, yet powerful tool as displayed in **Figure 8.2**.

Annex 1
 TopSpec Consortium exploitation and dissemination activity tracker (to be kept updated)



Person	Institution	Activity	Type of activity	Status	Result	Date of completion	Comments
David Kilgour	Nottingham Trent University, UK	Dissemination	Promotional collateral	In-progress			
Susanna Lundström	Karolinska Institutet, Stockholm, Sweden	Dissemination	Website contribution	In-progress			
Susanna Lundström	Karolinska Institutet, Stockholm, Sweden	Dissemination	Twitter post	In-progress			
Susanna Lundström	Karolinska Institutet, Stockholm, Sweden	Dissemination	LinkedIn post	In-progress			
Susanna Lundström	Karolinska Institutet, Stockholm, Sweden	Dissemination	Presentation at scientific conference	Completed			
David Kilgour	Nottingham Trent University, UK	Dissemination	Promotional collateral	Completed		3-12-2019	Created promotional banner for TopSpec
David Kilgour	Nottingham Trent University, UK	Dissemination	Peer-reviewed publication	Completed	Published	21-10-2019	
David Kilgour	Nottingham Trent University, UK	Dissemination	Workshop	Completed	Published	28-9-2019	Taught at MS Proteomics Bootcamp Workshop at IITB in Mumbai. Discussed TopSpec Project with attendees.
David Kilgour	Nottingham Trent University, UK	Dissemination	Workshop	Completed	Published	20-9-2019	Presented aspects of top-down sequencing software development at Ardour Symposium
Dimitris Papanastasiou	Fasmatech, Athens, Greece	Dissemination	Presentation at scientific conference	In-progress		jun-20	Multiple-stage Top-Down MSn analysis of antibodies in the Omnitrap Platform
Dimitris Papanastasiou	Fasmatech, Athens, Greece	Exploitation	Demonstration of technical capabilities	In-progress		Running	Demo lab established in Athens for top-down analysis of proteins
Dimitris Papanastasiou	Fasmatech, Athens, Greece	Dissemination	Peer-reviewed publication	Completed	Published		JACS paper in Thermal H gun published in 2018 together with R Zubarev - Karolinska
Dimitris Papanastasiou	Fasmatech, Athens, Greece	Dissemination	Peer-reviewed publication	In-progress			Main article introducing the omnitrap platform (Karolinska-Thermo)
David Kilgour	Nottingham Trent University, UK	Dissemination	Presentation at scientific conference	In-progress		31-1-2020	Bottom-up requirements for big data David Kilgour (Nottingham Trent University, UK)
Jonathan Dhenin	Institut Pasteur, Paris, France	Dissemination	Website contribution	In-progress			Advertisement for TopSpec on website of Institut Pasteur
Julia Chamot-Rooke	Institut Pasteur, Paris, France	Dissemination	Promotion of project in other meetings	Completed		6-12-2019	Advertisement for TopSpec to the committee of Region Ile-de-France responsible for project investments in human health and infectious diseases
Julia Chamot-Rooke	Institut Pasteur, Paris, France	Dissemination	Presentation at scientific conference	Completed		3-12-2019	Advertisement for TopSpec at Journées Utilisateurs Orbitrap, Paris, France
Mathieu Dupré	Institut Pasteur, Paris, France	Dissemination	Presentation at scientific conference	Completed		17-9-2019	Advertisement for TopSpec at SMAP2019, Strasbourg, France
Julia Chamot-Rooke	Institut Pasteur, Paris, France	Dissemination	Participation in activities organised jointly with other H2020 project	Completed		25-26/04/2019	Advertisement for TopSpec during the kick-off meeting of EPIC-XS, Amsterdam, Netherlands
Julia Chamot-Rooke	Institut Pasteur, Paris, France	Dissemination	Promotion of project in other meetings	Completed		10-4-2019	Advertisement for TopSpec to multiple pharma companies (potential collaborators)
Julia Chamot-Rooke	Institut Pasteur, Paris, France	Dissemination	Organisation of a conference	Completed		12-14/02/2019	1st European Top-Down Proteomics Symposium, Paris, France

Figure 8.2. Dissemination activities undertaken by the TopSpec project partners.

Besides the TopSpec website, a Twitter account (<https://twitter.com/TopSpecMS2>) and a LinkedIn page (<https://www.linkedin.com/company/topspecms/>) have been created.

In order to promote the project at various meetings and conferences a banner (shown in **Figure 8.3**) and a logo have been created.

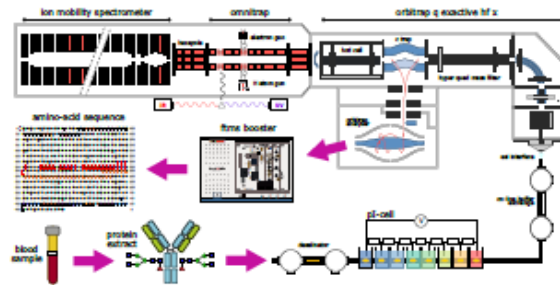

“Next generation precision antibody profiling – from science fiction to reality”

Members of the TopSpec research project consortium:



This research project has received funding from the European Horizon 2020 research and innovation program under grant agreement No 829157

Figure 8.3. Project banner prepared by the TopSpec project partners.

Task 8.2 Knowledge Management and IPR. M1-M36 - Management of the pre-existing knowledge needed to achieve the work (**background**), the knowledge created during the project (**foreground**), and the knowledge created in parallel to the project (**side-ground**) by either partners or other parties that might impact the project.

Action: The background knowledge has been described in the grant proposal. Foreground and side-ground knowledge will follow the data management plan as described in Deliverable 9.2. Intellectual property rights (IRP) have been described in the deliverable D8.1 TopSpec Intellectual Property Protection Strategy.

Task 8.3 Exploitation strategy of the results M1-M36 - Identification of the internal and external stockholders. - Determining the synergies between them to integrate the results, identify the weak points, assess the usability of the results. - Identify the competing technical approaches - Analyze the evolving socio-economic context including user needs, overall market trends.

Action: The exploitation strategy has been briefly described in the draft dissemination and exploitation plan and will be further discussed between the stakeholders during the upcoming project meetings.

Task 8.4 Demonstration workshop M22 - The stakeholders identified and presented in 8.3 will be invited to analyze project results in order to evaluate the scientific relevance, performance and transferability of the technology.

Task 8.5 Management of patent strategy and freedom to operate (FTO), M1-36. - Develop an IP protection strategy at the start of the project (M3). - Monitor that the newly created IP falls under the Consortium Agreement.

Action: The IP protection strategy with a deliverable document D8.1 TopSpec Intellectual Property Protection Strategy has been finalized in April 2019. The document has the dissemination level: Confidential and therefore has not been made public.

Task 8.6 Public engagement, M1-36. - Create articles with easy public access through project website - Publish popular articles in general science magazines - Giving interviews to news reporters (newspapers, TV, radio etc.)

Action: Currently we have one main video appearance - Fasmatech hosting the Former Prime Minister of Greece – Alexis Tsipras – at a visit to the Fasmatech Omnitrap lab in Athens <https://topspec.ki.se/2019/09/10/former-prime-minister-of-greece-alexis-tsipras-visits-omnitrap-lab-in-athens/>

The creation and publication of popular articles and media appearances will be more frequent once results obtained with the technology are available for the public.

Task 8.7 Develop and implement a common business strategy for market introduction. M12-36. - Develop a common business strategy for market introduction through consultations within Consortium. - Implement the developed business strategy for market introduction.

Action: A detailed business strategy document will be prepared by the consortium partners, detailing the market size and potential of the developed technology. Stakeholders will be identified as well as the usability of the results.

Task 8.8 Organizing relevant conferences: M6-36. - Organizing a conference of the UppCon series (Uppsala conference on Electron Capture Dissociation and related phenomena, run since 2003). - Organizing a conference on Top-down analysis of proteins; - Organizing a summer school on Electron Capture Dissociation and related phenomena Top-down analysis of proteins, as part of the annual MSBM (MS in biotechnology and medicine) summer school in Dubrovnik, Croatia. - Organizing hands-on course will be arranged at KI, and will be open to European students.

Action: The 1st European Top-Down Proteomics Symposium, Paris, France has been organized by the Institute Pasteur at which the TopSpec project has been highlighted. Scientific presentations have been given at the SMAP meeting in Strasbourg, EPIC-XS meeting in Amsterdam and the Ardgour Symposium in the UK. The Institute Pasteur has participated in a Orbitrap LC-MS workshop (Journées Utilisateurs Orbitrap, Dec2019, Paris). The Uppcon conference, centered around electron capture dissociated technology and applications, will be organized in Oregon state US in August 2020 weblink: <http://blogs.oregonstate.edu/upcon2020/>. Once results obtained with the technology are available for the public we will also focus on appearing at and organizing conferences and teaching tutorials.

Task 8.9 Communication to commercial research organizations. M12-36. - As we anticipate significant interest in TopSpec from the Pharma industry, we will act through technical media channels, B2B, fairs and conferences.

Action: The project and the top-down MS sequencing technology and it's capabilities have been presented to several pharmaceutical companies by Institute Pasteur (IP): Sanofi-Aventis and Servier. These pharmaceutical companies have shown interest in potential of the Omnitrap technology and the whole TopSpec project for their own biopharmaceutical compounds. One of these companies has requested us to analyse some of their Antibody-based compounds. One of these companies also would like to start a PhD in collaboration with us on the project. Additionally, the IP has presented the TopSpec project and activities in the field of human health and infectious diseases to a committee of the region Ile-de-France. The audience reached with the activities described in tasks 8.8 and task 8.9 are estimated to be 300 scientists from academia and industry, 10 industrial partners and 10 investors.

1.2.9 Work package 9

D9.1 Logo and Website launch and public accessibility

A project logo (Figure 9.1) and website (<https://topspec.ki.se/>) were released and made accessible for the public in February 2019. The website is maintained and updated by KI. The deliverable is described in detail in deliverable D9.1. In addition to the logo, we have also created an TopSpec icon logo that can be used for social media such as Twitter and LinkedIn (Figure 9.2).



Figure 9.1. The TopSpec project logo.



Figure 9.2. TopSpec project icon used for social media such as Twitter and LinkedIn has been made.

The web page features:

Content:

- BACKGROUND – Project background description
- PROJECT – Project description
- PARTNERS – Partner, PI and task information
- NEWS & EVENTS – Frequently updated (contain 8 posts from 2019).
- PROGRESS – Project timeline, updated according to deliverables and milestone progress. Public deliverable documents are available for download.
- PUBLICATIONS – Is updated according to new publications.
- DOCUMENTS – Password protected. Contains all documents related to the project.
- SOFTWARE – Will be updated with TopSpec software.

Acknowledgement:

All pages contain an acknowledgement to the Horizon 2020 funding (Figure 9.3).



Figure 9.3. Screenshot from the TopSpec webpage of the the Horizon 2020 funding acknowledgement that appears on all pages.

Public communication:

The general public has the option to contact the main project partner via the webpage and can give comments and feedback directly in the News & Events section. Links to LinkedIn and Twitter are also given in the footnote on all pages.

D9.2 Data management plan

A data management plan (DMP) was prepared according to the EU rules and guidelines and submitted in June 2019. The deliverable is described in detail in deliverable D9.2. Bellow follows a brief description of the key sections in the DMP.

Expected Data and/or Intellectual Property (IP) description:

- **WP1:** Omnitrap; Mechanical design, ion optical simulations, electronics design/synchronization, mechanical & vacuum assembly, hardware and software.
- **WP2:** Omnitrap; Implementation – various MS/MS techniques, and Application - protein/immunoglobulin analysis.
- **WP3:** Hyper-thermal H-atom gun; Design, hardware and software development as well as protein/immunoglobulin analysis.
- **WP4:** Coulomb explosion MS/MS technique; Design, hardware and software development as well as protein/immunoglobulin analysis.
- **WP5:** pI-Trap-ESI instrumentation; Design, hardware and software development/optimization for larger proteins as well as protein/immunoglobulin analysis.
- **WP6:** Modified Orbitrap mass spectrometer interfaced with the Omnitrap; Design, hardware and software development/configuration/optimization as well as protein/immunoglobulin analysis.
- **WP7:** Signal detection and data processing software's: Development/optimization/evaluation of 1) Data acquisition system (FTMS Booster), 2) Data processing software for protein Top Down analysis and 3) Data processing software for immunoglobulin Top Down analysis.

The DMP follows the Open Access (OA) policy as depicted in the decision-based scheme outlined in **Figure 9.4**.

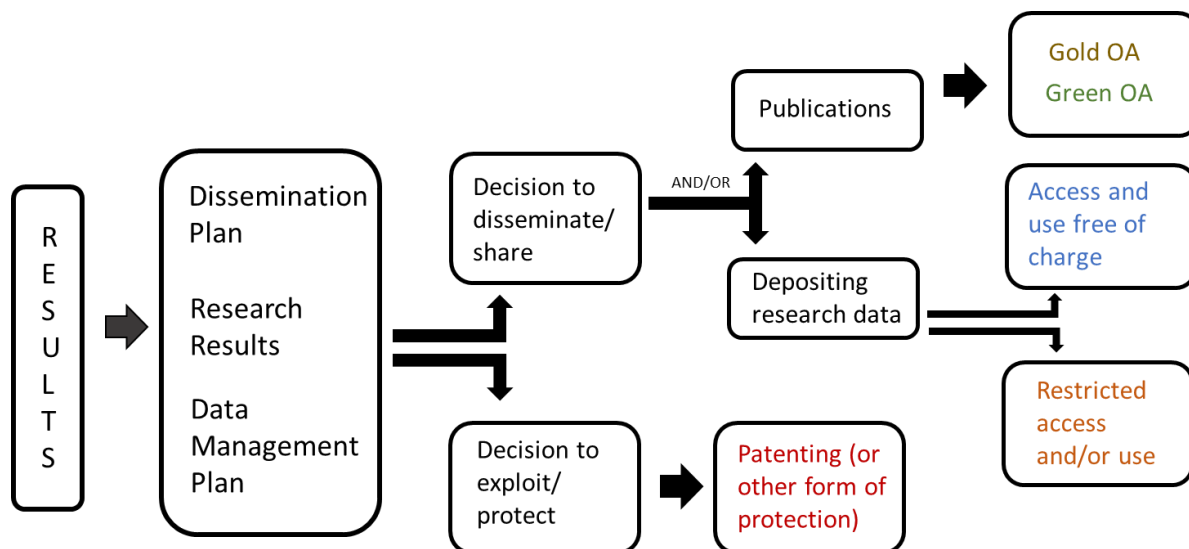

Figure 9.4. Decision scheme and open Access (OA) policy of TopSpec. Decisions will be based according to the guidelines of the DP, DMP and as decided by the editorial committee described in the text below.

Editorial committee: An editorial committee (KI, FASMATECH THERMO FISHER, SPECTROSWISS, BIOMOTIF, TNTU, IP, MS VISION), has been established for internal review of results generated in TopSpec prior presentation to the general public. This includes review of booklets, videos, manuscripts, presentations, posters, leaflets, software, hardware etc.

Non-confidential information: Non-confidential reports, technical leaflets and presentations both with or without peer-review process in English or local language shall be archived at the TopSpec webpage.

Scientific publications: All scientific publications of TopSpec will be proof-read by the editorial committee prior publication to ensure the quality and coherence of the manuscript as well as to protect potential IP rights of co-authors and innovation for exploitation. All peer-reviewed scientific publications will be published as open access either as “Gold” standard (immediate access by scientific publisher) or as “Green” standard (as online self-archiving, latest 6 months following publication).

Access and confidentiality: Preliminary data will only be accessible to the involved partners of respective WP. As agreed by the Consortium Agreement (CA) by each partner, all information declared as confidential background information will be kept as confidential. However, access right to results and background needed for the performance of the own work of a party under the TopSpec project shall be granted on a royal-free basis, unless otherwise agreed for in the CA. Finalized data will be available to all TopSpec partners and linked collaborators that need these data as input for their tasks. However certain data and information might be excluded from the open data strategy if there are for example commercial interests (IP right protection for result exploitation) or if data are not yet published in peer-reviewed papers. If there is no request for confidentiality, summarized data and results should be made available to all TopSpec partners and beyond. Thus, software, data and

research results that are not protected by IP rights and are no longer confidential (i.e. after publication) will be published on the TopSpec homepage.

FAIR data: The TopSpec webpage which will be the primary source to store all public results and documentation, as well as to get access to instructions, videos and software's generated both during and following the expiration date of TopSpec. The TopSpec technology will further be spread via open demonstrations and public workshops and lectures throughout the course of the project and beyond.

D9.3 Technical/scientific review meeting documents

Has been prepared and submitted in January 2020.

D9.4 Review meetings - report

Will be prepared and submitted in December 2021.

Other:

- The KI administration has ensured that all legal agreements are in place before start.
- Consortium and steering group meetings have been organized and documented in Athens (March 2019) and in Bremen (September 2019). The next meeting will take place in Montreux (March 2020).

1.3 Impact

1.3.1 Impact on technology and society

The transformational opportunity: If successful, TopSpec will provide a new tool that can be used to greatly expand our knowledge of the human immune system and have a dramatic impact on the field of personalized, precision medicine. Another significant impact will be in the field of MS instrument design.

Specific impacts: 1) Increase in the speed of diagnosis and in the speed of drug development. 2) Increase knowledge on an individual's antibody response to disease. 3) Contribute to the growth and expansion of 4 European SMEs. 4) Expand scientific research around proteomics. 5) Create new business opportunities within and outside the project.

Sustainability and equity of the European Health system: A major challenge in all health systems is the cost of drugs and targeted therapies. Reducing time taken to develop novel therapies, will reduce costs to the health system.

2. Update of the plan for exploitation and dissemination of result

Not applicable.

3. Update of the data management plan

Not applicable.

4. Follow-up of recommendations and comments from previous review(s)

Not applicable.

5. Deviations from Annex 1 and Annex 2

Four out of five milestones of the first year have been reached and the deliverables delivered in time. "Milestone M4. "Omnitraps & IMS P.O.s sent to suppliers" will be finalized in February 2020. The original plan of producing two identical omnitraps for the Q Exactive HF instrument series has been revised. Instead two platforms, one compatible with the Q Exactive HF and a separate omnitrap sub-platform compatible with the new Exploris 480 instrument series have been designed. This latter sub-platform will exploit the enhanced sensitivity and mass resolution capabilities of this newest version of the orbitrap mass analyzer.

5.1 Tasks

Minor changes have been made as described in section 1.2.

5.2 Use of resources

Preliminary, the use of resources for the review period is in line with Annex 1. More details will be given in the financial report (deadline February 29th).

5.2.1 Unforeseen subcontracting (if applicable) (not applicable for MCSA)

Not applicable.

5.2.2 Unforeseen use of inkind contribution from third party against payment or free of charges

Not applicable.